

ROMAEL



Romans

Youth Bible Study

by Pat Kampenga

Master Copy: May be duplicated for the use of your group only.

Joy of Living Romans Youth Bible Study

Copyright 2001 • **Joy of Living Bible Studies** • Ventura, CA
(800) 999-2703 • (805) 650-0838 • Fax: (805) 650-6730 • E-mail: info@joyofliving.org

Romans

Youth Bible Study

by Pat Kampenga

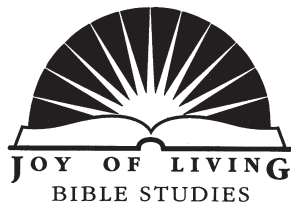

Before you begin

An ideal curriculum for home-school, Bible class, Sunday School or personal Bible Study, **Joy of Living Youth Curriculum** is flexible and easy to use. Each lesson covers the same scripture passage as the adult **Joy of Living** Study.

Age:

This course encourages students of various ages to develop a habit of personal Bible study. Since the study requires reading the Bible and writing answers to the questions, the minimum age should be about 6 years old. Although the questions are geared to about age 10, older students will profit by gaining a basic knowledge of the Bible. Students over the age of 14 may be mature enough to study the adult **Joy of Living** course.

The lessons:

The study is divided into weekly units. Each week is divided into three sections:

- a suggested class schedule including craft and game ideas
- leader's lesson sheets (these contain the answers for the lesson completed by the students during the previous week)
- student questions for the next lesson (these are passed out at the end of the class)

Students complete the written lessons at home and are encouraged to do a few questions each day rather than trying to complete all the questions in one day. This will aid the students in developing a pattern of daily Bible Study. The "HARD" and "RISKY" questions are to inspire the student to think and reason and help them dig deeper into God's Word.

For homeschool or personal Bible study:

The curriculum may be used in a variety of ways:

- Lessons may be completed by the individual student and graded for accuracy. Discussion time is optional, although it is encouraged.
- Students within the same family or group may work on the lessons together. A discussion time with a parent or other adult is suggested.
- Adults may work one-on-one with the student(s) while they complete the lesson.
- Lessons may be used as part of family devotions. Read the portions of scripture aloud and use the questions to prompt discussion of the Bible passage.

For use with groups:

There is great flexibility in implementing this curriculum. Since each class has its own needs, space, finances, and time frame the class schedule is supplied as a general outline and can be changed to suit specific situations and needs.

Each class session has free time, recreation/snack time, question discussion time, and craft time.

Remember - Keep the pace moving to avoid boredom and trouble, while providing continuity.

Suggested time SCHEDULE to be adapted to individual group:

- 15 - 20 minutes. - unstructured free time
- 15 - 20 minutes. - game/snack time
- 15 - 20 minutes. - discussion time
- remaining time for craft

Helpful Hints for Groups

Facility/Equipment

- Whatever the class size, access to a gym or large game room is worthwhile for team play and group activities.
- If the church has the room, a separate cupboard for supplies is a plus.
- A volleyball or similar ball is good to have on hand for a variety of games.

Discussion Time

- Use the counting off system to divide the class into groups for discussion time. (Avoid, if possible, separating into groups according to age or family.)
- Each discussion group should have an adult leader. Older children should not be used (unless absolutely necessary) as leaders or sitters; they are there for fellowship and learning, too.
- With many of the questions there is no right or wrong answer. The questions are to encourage the student to think and reason and to dig deeper into God's Word. However, since discussion time is also a form of teaching, the leaders are given answers on their question sheets to aid them in the discussion, with occasional commentary insights added in brackets.
- As you discuss the lesson be careful not to belittle a student's opinion or idea. Even if the answer is wrong you can encourage the student by saying something similar to, "I like to see that you're thinking, do you think perhaps....(then give the correct answer)" or "I can see that you are thinking about the question, does anyone else have thoughts on this question?"

Teachers/Leaders/Helpers

- The number of leaders and helpers is determined by the size of the class. The ideal situation is one discussion leader per every 5 children.
- In addition to the main leader, it is helpful to have a game leader, and craft leader.

- Responsibilities are determined within each class structure.
- Parent volunteers may be requested when extra help is needed. If there is a large number of children, the parents have to volunteer only once or twice the entire year.
- Scheduling parents to bring treats is a financial bonus. Keeping cost to a minimum is being a good steward of God's resources.

Game Time

Although board games, puzzles, hidden pictures, crosswords, coloring, and quiet activities do not keep the attention of active children, they should not be ruled out as alternative game time activities. Ball games, races, or tag games are suggested and favored to holding everyone's interest.

Suggestions for obtaining craft ideas & supplies:

Garage/yard/rummage sales

library craft books

children's magazines

YMCA, Park & Recreation Dept., churches (almost every city has a summer program for children, which includes a craft time; they may have leftover craft supplies they would like to donate)

Supplies to have on hand for crafts not in kits:

glue, glue sticks, glue gun

scissors (at least 1 pair for every 2 students)

paint (tempera-washable)

paint brushes

paper towels

newspapers

construction paper

crayons

colored markers

colored pencils

paper cups, napkins (snack time)

various items to pass in relay races

balls, basketball, nerf, etc.

Scripture quotations in this course are from:

The Simplified Living Bible (TSLB) copyright 1990 by KNT Charitable Trust. The Simplified Living Bible is adapted from The Living Bible. Copyright " 1971 owned by assignment by KNT Charitable Trust. Used by permission of Tyndale House Publishers. Inc., Box 80, Wheaton, Illinois 60189.

Also quoted is the *Life Application Bible*, New International Version edition (NIV), published jointly by Tyndale House Publisher, Inc. and Zondervan Publishing House, copyright 1988, 1989, 1990, 1991, by Tyndale House Publishers Inc., Wheaton, Il. 60189.

Also quoted is *The Quest Study Bible*, New International Version edition (NIV), published by Zondervan Publishing House, copyright 1994, by the Zondervan Corporation., Grand Rapids, Michigan, 49530.

Also quoted is *The Message, New Testament with Psalms and Proverbs*, by Eugene H. Peterson. NavPress Publishing Group. Colorado Springs, CO. 80935. Copyright 1993,1994,1994 by Eugene H. Peterson.

The Ryrie Study Bible, New American Standard Translation (NAS) copyright 1976, 1978 by The Moody Bible Institute of Chicago. The Scripture text of the New American Standard Bible are used by permission of the Lockman Foundation, La Habra, California, 1960, 1962, 1963, 1968, 1971, 1972, 1973, 1975, 1977.

BIBLIOGRAPHY

- Fleming H. Revel Co. Publishers. *Ripley's Believe it or Not: The World of Religion*. Copyright 1967 by Ripley Enterprises, Inc. Fleming H. Revell Co., Westwood N.J.
- G. & C. Merriam Company, Publishers. *Webster's Seventh New Collegiate Dictionary*. Springfield, MA: G. & C. Merriam Company, Publishers, 1967.
- Gospel Light Publications. *The Bible Story Clip Art Book*. Gospel Light Publications, Ventura, CA 93006, 1989.
- Gospel Light Publications. *A Backpack of Crafts*. Gospel Light Publications, Ventura, CA 93006, 1986.
- Gospel Light Publications. *Celebrating Families*. Gospel Light Publications, Ventura, CA 93006.
- Gospel Light Publications. *Safari Crafts*. Gospel Light Publications, Ventura, CA. 93006.
- Gospel Light Publications. *Backpack of Crafts*. Gospel Light Publications, Ventura, CA. 93006.
- Guideposts, Publishers. *The International Bible Commentary, with the New International Version*. Originally Edited by F. F. Bruce, H. L. Ellison, G. C. D. Howley. First published 1979. Based on RSV version of the Bible. Copyright Picering & Inglis Ltd. 1979. New Edition 1986. Based on the New International Version of the Bible. Copyright Marshall Morgan and Scott Publications Ltd. 1986, England and Zondervan Publishing House, Grand Rapids, Michigan.
- Holt, Rinehart & Winston, editors. *The Holt Intermediate Dictionary of American English*, New York: Holt, Rinehart & Winston. Inc. 1967,66.
- Hammond & Co. *Atlas of the Bible Lands*. Copyright MCMLIX by C.S. Hammond & Co., New York
- Illustrated World Encyclopedia*, Woodbury, N. Y. 1966.
- Insight for Living. Charles R. Swindoll, *Coming to Terms With Sin, Bible Study Guide*. Insight for Living, Anaheim, CA. 1999.
- Moody Press, Publishers. *Unger's Bible Dictionary*. Chicago, IL: Moody Bible Institute of Chicago. 1966.
- Regal Books, Publishers. *Reproducible Maps, Charts, Time Lines & Illustrations* Ventura, CA: Regal Books, A Division of Gospel Light Publications.
- Thru the Bible with J. Vernon McGee*. Thru the Bible Radio, Pasadena, CA 91109. Copyright 1983 by J. Vernon McGee.
- Victor Books, Publishers. *The Bible Knowledge Commentary*. Editors John F. Walvoord, Roy B. Zuck. Victor Books, A Division of Scripture Press Publications, Inc., 1985, SP Publications, Inc.
- Walk Thru the Bible Ministries, Inc., 1981.
- Word Books, Publishers. Ray C. Stedman, *Expository Studies in Romans: From Guilt to Glory, Vol. 1-2* Waco, TX: Word Books. 1978.

Romans — Game & Craft List

	Game	Craft	Page
Week 1	Balloon Relay	Resist & Print	8
Week 2	Balloon Volleyball	Experiment	12
Week 3	Simple Relay	Plaster of Paris Wall Plaque	19
Week 4	Car Lot	Napkin Folder	26
Week 5	Knee Relays	Film Strip Viewer	34
Week 6	Card Toss	Homemade Water Colors	45
Week 7	Chain Tag	Tile Magnet	52
Week 8	Bedlam	Wind Twirler	60
Week 9	My Father Doesn't Like	Christmas Wreath	69
Week 10	Anatomy Shuffle	Trinket or Favor Basket	78
Week 11	Silly Hand Relay	Decorated Pencil Holder	88
Week 12	Newspaper Ball Toss	Coasters	95
Week 13	Bedlam	Windsock	102
Week 14	Chain Tag	Fun Science	109

ROMANS - WEEK ONE

NO LESSON DISCUSSION

15 - 20 minutes free time — games, fellowship; you may want to begin the craft early.

15 - 20 minutes snack and group recreation: BALLOON RELAY

Divide into two teams behind the start line. At the opposite end of the room, place a chair for each team. Give each player a balloon. Each player must blow up the balloon just prior to his turn to run. The first player blows up his balloon and runs to the opposite chair. He puts the balloon on it and bounces on it until it pops. If it doesn't pop on the first try, he continues bouncing until it does pop. When it does pop, he races back to the second player, tags him, and then the balloon is blown up and race resumes. The first team to pop all their balloons wins.

15 - 20 minutes discuss class rules

to end of class CRAFT: RESIST & PRINT

MATERIALS:

2 sheets drawing paper per child
light-colored crayons
pan of cold water
tempera paint (dark color)
paint brushes
newspapers

Using a light-color crayon, draw heavily a design or picture on the drawing paper. Crumple this paper: dip it into the pan with cold water, then squeeze the water out of the paper so that it isn't dripping. Spread the drawing face-up on the newspaper. Give the picture one quick coat of dark color paint. Place the other sheet of drawing paper on top and press evenly with the hand. The second piece of paper will soak up the extra paint and will give you a print of the crayoned picture.

ROMANS - LESSON 1

Before you begin your lesson:

- a. Pray for God's Holy Spirit to help you answer the questions.
- b. Some questions may be too hard; it's ok to write "I don't know."
- c. Think about what God's Word is telling you for today.
- d. With some questions, it might be helpful to write the scripture verse on your paper.

At one time, the Roman Empire ruled over most of the civilized lands of the world. The countries we know as Great Britain in the northwest, Armenia in the northeast, Egypt in the southeast, to Morocco in the southwest, were under Roman rule until about 117 AD. It is believed this letter to the Romans was written between AD 56-58, about the middle of the Roman Empire's rule. Today, the names of those countries under Roman rule would be: Great Britain, The Netherlands, parts of Germany, the Czech Republic, Bosnia, Croatia, Romania, Hungary, Turkey, Bulgaria, Greece, Israel, Jordan, Syria, Egypt, Libya, Algeria, Morocco, Spain, France, and Italy. If you have a world map, look these countries up and see the large area under Roman rule.

The Romans were the best in engineering, war, and government. They fought many wars and made the prisoners their slaves. Just before Jesus Christ was born, most of the world that was known was at peace and under this Roman rule. Rome was also known to have very low morals, and encouraged others to live the same way.

There was no church in Rome, but there were believing Jews and Gentiles as well as those who did not believe in Jesus. No missionary with the gospel had yet been to Rome. However, some scholars believe there were people from Rome (Acts 2:10) visiting Jerusalem at the time of Pentecost who heard Peter's sermon and saw the miracle of the tongues of fire. Some were probably part of the 3,000 converts (Acts 2:41). Also, it is possible other believers moved to Rome through the years and witnessed their faith to the unbelievers.

Acts 2:10: "Others of us are from Phrygia, Pamphylia, Egypt, and the Cyrene language areas of Libya. Some of us even came from Rome, both Jews and Jewish converts."

Acts 2:41: "And all those who believed Peter were baptized. There were about 3,000 of them in all!"

Read Romans chapter 1, verses 1 - 7.

1. When you write a letter, where do you put your name?
2. Where did Paul put his name?

3. What do you learn about Paul in Romans 1:1?

4. What does God say about Paul in Acts 9:15?

5. What does Titus 1:2 say is the promise God made, and when did He make it?

6. Read John 1:1,2. Who does John say was also there when this promise was made?

7. **CHALLENGE:** How did Jesus prove He was the Son of God?

8. What does Matthew 1:21 say Jesus was to do?

9. Who did Paul call “saints” in Romans 1:7a?

Read Romans chapter 1, verses 8 - 17.

1. **HARD:** Why did Paul thank God for the Roman believers?

2. **PERSONAL:** Can your faith in Jesus be written about as was the faith of those people who lived in Rome at the time this letter was written?

3. What was Paul's prayer request in Romans 1:10?

4. What was the reason Paul made this prayer request?

5. What does Paul want the Romans to know?

6. What is Paul eager to do?

7. What does Paul say about himself and the gospel?

8. How are those who believe in the Gospel supposed to live?

9. **PERSONAL:** Knowing what the Bible says helps us to live the way God wants us to live. One way to know the Bible is to memorize some verses in it. Choose a verse you liked and memorize it. Then share this with your class.

ROMANS - WEEK TWO

DISCUSSION LESSON ONE

15 - 20 minutes free time - games, fellowship

15 - 20 minutes snack and group recreation: BALLOON VOLLEYBALL

Push a small marble or smooth stone through the neck of a deflated round balloon. Blow up balloon. This “ball” is difficult to control. Mark a play area. Tie a length of rope across the middle of play area about 5 feet high. Divide into two teams. Choose one team to begin the play by hitting the “ball” across the “net” (rope). If the “ball” hits the ground on the receiving side, the hitting team scores a point. If the “ball” goes out of the play area, the hitting team loses a point. The “ball” can be hit as many times as necessary to get it across the “net” onto the ground of the opponents’ play area. Caution not to hit the “ball” too hard so that it pops. The first team to reach 7 points wins.

15 - 20 minutes discuss LESSON 1

to end of class CRAFT: EXPERIMENT

MATERIALS

3 glasses filled to three different levels, spoon

The water levels represent high, medium, and low tones, or “do, re, mi.” The following two songs can be played on the glass chimes. “L” is for “low,” “M” is for “medium,” “H” is for “high.” The hand should be relaxed and the spoon held as lightly as possible. Try other songs using the same three levels of water. Or change the levels of water for a different tone.

HOT CROSS BUNS

Hot cross buns

H M L

Hot cross buns

H M L

One a penny

L L L L

Two a penny

M M M M

Hot cross buns.

H M L

MERRILY WE ROLL ALONG

Merrily we roll along

H M L M H H H

Roll along

M M M

Roll along

H H H

Merrily we roll along

H M L M H H H

O’er the deep blue sea.

M M H M L

ROMANS

LESSON 1 ANSWERS

At one time, the Roman Empire ruled over most of the civilized lands of the world. The countries we know as Great Britain in the northwest, Armenia in the northeast, Egypt in the southeast, to Morocco in the southwest, were under Roman rule until about 117 AD. It is believed this letter to the Romans was written between AD 56-58, about the middle of the Roman Empire's rule. Today, the names of those countries under Roman rule would be: Great Britain, The Netherlands, parts of Germany, the Czech Republic, Bosnia, Croatia, Romania, Hungary, Turkey, Bulgaria, Greece, Israel, Jordan, Syria, Egypt, Libya, Algeria, Morocco, Spain, France, and Italy. If you have a world map, look these countries up and see the large area under Roman rule.

The Romans were the best in engineering, war, and government. They fought many wars and made the prisoners their slaves. Just before Jesus Christ was born, most of the world that was known was at peace and under this Roman rule. Rome was also known to have very low morals, and encouraged others to live the same way.

There was no church in Rome, but there were believing Jews and Gentiles as well as those who did not believe in Jesus. No missionary with the gospel had yet been to Rome. However, some scholars believe there were people from Rome (Acts 2:10) visiting Jerusalem at the time of Pentecost who heard Peter's sermon and saw the miracle of the tongues of fire. Some were probably part of the 3,000 converts (Acts 2:41). Also, it is possible other believers moved to Rome through the years and witnessed their faith to the unbelievers.

Acts 2:10: "Others of us are from Phrygia, Pamphylia, Egypt, and the Cyrene language areas of Libya. Some of us even came from Rome, both Jews and Jewish converts."

Acts 2:41: "And all those who believed Peter were baptized. There were about 3,000 of them in all!"

Read Romans chapter 1, verses 1 - 7.

1. When you write a letter, where do you put your name? Today, the sender of the letter signs it **at the bottom**, which is called the signature.
2. Where did Paul put his name? Paul put his name **at the beginning** of the letter. We call that the salutation, or Dear.
3. What do you learn about Paul in verse 1? "This letter is from Paul, **Jesus Christ's slave**. I was **chosen to be a missionary**. And **I was sent out to preach** God's Good News." [The word gospel also means "good tidings, good story." In the earlier Greek language [it] signified 'a present given to one who brought good tidings', or 'a sacrifice offered in thanksgiving for such good tidings having come'" (UNGER'S). An apostle was someone sent with a special message. An apostle of Jesus Christ is sent by Him with His message.]

4. What does God say about Paul in Acts 9:15? “But the Lord said, ‘Go and do what I say. For **Saul is my chosen instrument. He will preach my message to the Gentiles and their kings. He also will preach to the people Israel.**”
5. What does Titus 1:2 say is the promise God made and when did He make it? “I have been sent to bring faith to those God has chosen. I am to teach them to know God’s truth. For it is the truth that changes lives. And by that truth they can have **eternal life.** God promised eternal life to them **before the world began,** and he cannot lie.”
6. Who does John say in John 1:1,2 was also there when this promise was made? “Before anything else existed, there was **God’s Son.** He was the Word, and he was with God. He has always been alive and is himself God.”
7. **CHALLENGE:** How did Jesus prove He was the Son of God? Verse 4: “**By rising from the dead,** Jesus proved he was God’s Son. He showed that he was God.” [Jesus didn’t regain His deity when He rose from the dead. The resurrection confirmed His deity.]
8. What does Matthew 1:21 say Jesus was to do? “She will have a Son, and you shall name him Jesus. This means ‘Savior,’ for he will **save his people from their sins.**” [Unless Jesus had been born, eternal life and salvation from sin was not possible.]
9. Who did Paul call “saints” in Romans 1:7a? “**To all in Rome who are loved by God and called to be saints**” (NIV).

Read Romans chapter 1, verses 8 - 17.

1. **HARD:** Why did Paul thank God for the Roman believers? “Wherever I go you are being talked about! **For your faith** in God is becoming known around the world. I thank God through Jesus Christ for this good report. I thank him for each one of you.” [To be a believer in Christ in Rome required a complete change of lifestyle based on faith in Jesus Christ. Most people in Rome lived immoral lives; to be a Christian meant you lived with a different set of standards. It was probably harder to live as a Christian in Rome than it is to live as a Christian in America today. That is why the Romans’ faith was known throughout the world. In using the words “through Christ,” Paul points out that it is only through Christ that God sends His love and forgiveness. And in the same way, it is through Christ that believers give their thanks to God for all He has done, 1 Timothy 2:5.]
2. What was Paul’s prayer request in verse 10? “I pray for a chance, God willing, **to come to see you.** And I pray that I will have a safe trip.”
3. What was the reason Paul made this prayer request? Verses 11,12: “I want **to visit you** so that I can **give you faith.** This will help your church grow strong in the Lord. I want to share my faith with you. But **I want to be encouraged** by your faith, too. each of us will be a blessing to the other.”

- . What does Paul want the Romans to know? Verse 13: “I want you to know, dear brothers, that **I planned to come many times before.** But I couldn’t. I wanted to work among you and see good results. I have seen great blessings among the other Gentile churches.”
5. What is Paul eager to do? Verse 15: “So I am ready to **come to you** in Rome to **preach God’s Good News.**” [The people Paul mentions in verse 14 are: Greeks—those of the Greek culture; non-Greeks—those not of the Greek culture; the wise—those who are educated; the unwise—those who have not had an education.]
6. What does Paul say about himself and the gospel? Verse 16: “**I am not ashamed about Christ’s Good News.** It is God’s powerful way to bring all who believe it to Heaven. This message was first preached only to the Jews. But now everyone is asked to come to God in the same way.”
7. How are those who believe in the Gospel supposed to live? Verse 17: “This Good News tells us that God makes us ready for Heaven. He makes us right in God’s sight. This happens when we put our faith in Christ to save us. This happens from start to finish by faith. As the Bible says, “The man who finds life will find it **by trusting God.**” [Righteousness, used in many translations, is a hard word to understand. Through the death, burial, and resurrection of Jesus, those who believe in Him, have worth, or value in God’s eyes. This value is received by faith. It cannot be seen, tasted, felt, heard, or smelled. So every day must be lived by this faith that says “I have value in the eyes of God because I believe in His Son.”]
8. **PERSONAL:** Knowing what the Bible says helps us to live the way God wants us to live. One way to know the Bible is to memorize some verses in it. Choose a verse you liked and memorize it. Then share this with your class.

ROMANS - LESSON 2

Before you begin your lesson:

- a. Pray for God's Holy Spirit to help you answer the questions.
- b. Some questions may be too hard; it's ok to write "I don't know."
- c. Think about what God's Word is telling you for today.
- d. With some questions, it might be helpful to write all of the scripture verse on your paper.

Read Romans chapter 1, verses 18 -25, 28 - 32.

1. How did God show the people that there is one true God?

2. Which two verses tell you who the people worshiped instead of God?

3. God gives everyone the same chance to believe in Him or turn away from Him. What do these verses say about this choice?

John 3:16,17

John 1:12

4. Romans 1:28-32 tell how sinful people live. What do the following verses say is the way a believer in Jesus Christ should live?
Galatians 5:22

Ephesians 5:18

1 Peter 3:8

5. What do those who do not choose to obey God deserve?

6. People who sin break God's law. That's when they become separated from God. But there is a way that brings sinners back to God. What does 1 John 1:9 say is the way to have sins forgiven?

7. **PERSONAL:** Have you done what 1 John 1:9 says to do? This is something we need to do at least once every day; and as often as we know we have sinned.

Read Romans chapter 2, verses 1 - 4.

“Their lives became full of every kind of wickedness and sin. They were full of greed and hate, envy, murder, fighting, lying, bitterness, and gossip. They were backbiters, haters of God, insolent, proud, and braggarts. They could always think of new ways of sinning. They never obeyed their parents. They didn't want to understand. They broke their promises, and were heartless and without pity” Romans 1:29-31.

1. **PERSONAL:** have you ever done any of the sins listed in the above verses? Or have you judged someone else who may have done some of these things? What do these verses say about judging?

Matthew 7:1

Romans 2:1

2. **HARD:** Why does God wait to punish sinners?

Read Romans chapter 2, verses 5 - 16.

1. What does Romans 2:5 say the person who isn't sorry for his sins is piling up, or saving, for himself?

2. What do these verses say about piling up, or saving?

Matthew 6:19-21

1 Timothy 6:18,19

3. What will God give to the person who does evil and fights against God and His truth?

4. What will God command Jesus to do?

ROMANS - WEEK THREE

DISCUSSION LESSON TWO

15 - 20 minutes free time - games; fellowship

15 - 20 minutes snack and group recreation: SIMPLE RELAY

Form lines of 5-6 players, one behind the other, behind an imaginary (or real) line. At the opposite end, place a chair, or other object, or another imaginary line. First player in each line, at the signal races to the opposite goal line, or around the object, back to his line. Tags the next player in line and goes to the end of the line and sits down. Game continues until all players on one team are seated.

15 - 20 minutes discuss LESSON 2

to end of class CRAFT: PLASTER of PARIS WALL PLAQUE

MATERIALS

Plaster of Paris	toothpicks/pencil
plastic lid	decorative materials
pop can tab	paper clip
paint/brushes	small plastic figures
disposable container for mixing	paint

Mix Plaster of Paris according to package directions in a disposable container. Pour mixture into plastic lid from a coffee can, margarine tub, non-dairy whipped cream lid, or meat tray, etc. Before the plaster hardens, press hand into mixture (make a print), or press the small figures into it (lay the figures down, not standing), drop decorative materials, or write a scripture using the pencil or toothpick. Let the kids be creative. Before the plaster thoroughly hardens, press the pop can tab into the back of the plaque for hanging. Paint as desired.

ROMANS LESSON 2 ANSWERS

Read Romans chapter 1, verses 18 - 25, 28 - 32.

1. How did God show the people that there is one true God? Verses 19,20: “These men know the truth about God. God has taught them in their hearts. **Since earliest times men have seen the earth and sky and all God made.** That is how they know about God and his great eternal power. So they will have no excuse when they stand before God at Judgment Day.” [“Creation offers proof (for those willing to accept it) of a powerful “Someone” behind it all. The astronomical odds against this world happening merely by chance provide insurmountable evidence for a Creator. The intricate beauty and complex design of the creation — from subatomic particles and molecular building blocks of life to the galaxies and the expanses of the universe — demonstrate that a “Designer” planned it all” (QUEST). “The Greek word for wrath in this context means ‘God’s holy aversion to all that is evil.’ His wrath is not a sudden outburst of anger but a constant condition of hatred toward everything that violates His moral character. Man has set himself at odds with God by freely suppressing His truth ‘in unrighteousness.’ In so doing, he has become an object of God’s wrath” (SWINDOLL). But, instead of choosing to believe and obey God, people choose to ignore the truth He sent, and then they have no reason obey it. “Rejection of God begins in the heart which leads to worthless thinking in the mind, which in turn gives rise to greater moral insensitivity in the heart” (SWINDOLL).]

2. Which two verses tell you who the people worshiped instead of God? Verses 23,25: “They didn’t worship the great, ever-living God. Instead, they took **wood and stone and made idols for themselves.** They carved them to look like **birds and animals and snakes and men.** They didn’t believe in the truth they knew was from God. Instead they chose to believe lies. So they prayed to the things God made. But they wouldn’t obey the blessed God who made these things.”

3. God gives everyone the same chance to believe in Him or turn away from Him. What do these verses say about this choice?

John 3:16,17 “God loved the world so much that he gave his only Son. **Anyone who believes in him** will not die but **have eternal life.** God did not send his Son into the world to judge it. He sent his Son to save it.”

John 1:12 “But to **all who received him,** he gave **the right to become God’s children.** All they needed to do was to believe in him.”

4. Verses 28-32 tell how sinful people live. What do these verses say is the way a believer in Jesus Christ should live?

Galatians 5:22 “But with the Holy Spirit in **our lives there will be different** kinds of fruit. They are love, joy, peace, patience, kindness, goodness, and faith.”

Ephesians 5:18 “Don’t drink too much wine. Many evils lie along that path. **Be filled instead with the Holy Spirit** and be controlled by him.”

1 Peter 3:8 “Also, you should be like one big family. You should be full of kindness toward each other. **Love one another** with tender hearts and humble minds.”

5. What do those who do not choose to obey God deserve? Verse 32: “Although they know God’s righteous decree that those who do such things deserve **death**, they not only continue to do these very things but also approve of those who practice them.” (NIV)
6. People who sin break God’s law. That’s when they become separated from God. But there is a way that brings sinners back to God. What does 1 John 1:9 say is the way to have sins forgiven? “If we confess our sins, he can be depended on to forgive us. He will cleanse us from every wrong. It is proper for God to do this because Christ died for our sins.”
7. **PERSONAL:** Have you done what 1 John 1:9 says to do? This is something we need to do at least once every day; and as often as we know we have sinned.

Read Romans chapter 2, verses 1 - 4.

“Their lives became full of every kind of wickedness and sin. They were full of greed and hate, envy, murder, fighting, lying, bitterness, and gossip. They were backbiters, haters of God, insolent, proud, and braggarts. They could always think of new ways of sinning. They never obeyed their parents. They didn’t want to understand. They broke their promises, and were heartless and without pity” Romans 1:29-31.

1. **PERSONAL:** Have you ever done any of the sins listed in the above verses? Or have you judged someone else who may have done some of these things? What do these verses say about judging?

Matthew 7:1 “Don’t judge others. Then you won’t be judged.”

Romans 2:1 “You may say, ‘What terrible people you have been talking about!’ But wait a minute! You are just as bad. You say they are wicked and should be punished. But you do these very same things.”

2. **HARD:** Why does God wait to punish sinners? Verse 4: “Don’t you know how patient he is being with you? Or don’t you care? Can’t you see that he has been waiting all this time without punishing you? He is giving you time to turn from your sin. His kindness is meant to lead you to change.”

Read Romans chapter 2, verses 5 - 16.

1. What does Romans 2:5 say the person who isn't sorry for his sins is piling up, or saving, for himself? "But you won't listen. You are stubborn. You refuse to turn from your sin. So **you are saving up terrible punishment for yourselves.** There is going to come a day of anger. That is when God will be the Judge of all the world."
2. What do these verses say about piling up, or saving?

Matthew 6:19-21 "Don't store up treasures here on earth. For they can rust away or they might be stolen. Store them in Heaven where they will never lose their value. And there, they are safe from robbers. If your treasures are in Heaven, your heart will be there, too."

1 Timothy 6:18,19 "Tell them to use their money to do good. They should be rich in good works and give happily to those in need. They should always be ready to share with others whatever God has given them. By doing this they will be storing up real treasure for themselves in Heaven. This is the only safe way to save for the future! And they will be living a truly fruitful Christian life."

3. What will God give to the person who does evil and fights against God and His truth? Verse 8: "But he will terribly punish those who fight against the truth of God. God's anger will be poured out on people who walk in evil ways." [There are several answers to the question, "What about those who never heard about Jesus?" It is best to answer the question with scripture. Romans 2:12-15 "He will punish sin wherever it is found. The heathen never had God's written laws. But he will punish them when they sin. Down in their hearts they know right from wrong. God's laws are written within them. Their own heart accuses them, or sometimes excuses them. God will punish the Jews for sinning because they have his laws but don't obey them. They know what is right but don't do it. Salvation isn't given to those who know what to do, unless they do it." Hebrews 11:6: "You can never please God without faith. You cannot please him without depending on him. Anyone who wants to come to God must believe that there is a God. They also must believe that he rewards those who truly look for him." God has written His law on man's heart. The conscience knows right from wrong. And for those who truly want to know God, they will look for, or seek, Him, and He will answer their need.]
4. What will God command Jesus to do? Verse 16: "The day will come when God will command Jesus Christ to judge everyone's secret life. He will judge their inmost thoughts and motives. This is all part of God's great plan, which I am telling you about."

ROMANS - LESSON 3

Before you begin your lesson:

- a. Pray for God's Holy Spirit to help you answer the questions.
- b. Some questions may be too hard; it's ok to write, "I don't know."
- c. Think about what God's Word is telling you for today.
- d. With some questions, it might be helpful to write all of the scripture verse on your paper.

Read Romans chapter 2, verses 17 - 29.

Verses 12-15 say: "He [God] will punish sin wherever it is found. The heathen never had God's written laws. But he will punish them when they sin. Down in their hearts they know right from wrong. God's laws are written within them. Their own heart accuses them, or sometimes excuses them. God will punish the Jews for sinning because they have his laws but don't obey them. They know what is right but don't do it. Salvation isn't given to those who know what to do, unless they do it" (*The Bible for Children, Simplified Living Bible Text*).

1. What does Paul say about the Jews in verses 23,24?

2. When Paul wrote this letter, the only Bible around was the Old Testament. What does Ezekiel 36:22 say the Jews did to God's name?

3. **HARD:** *The Bible for Children, Simplified Living Bible Text* says in Romans 2:29, "No, a real Jew is anyone whose heart is right with God. For God is not looking for those who cut their bodies in circumcision. He is looking for people with changed hearts and minds. Whoever has that kind of change will be praised not by you but by God." Using this Bible version, from whom does the person whose heart and mind are changed get praise?

Read Romans chapter 3, verses 1 - 8.

1. What does 2 Timothy 2:13 say about God's faithfulness?

2. What do some people think Paul is telling them? See Romans 3:8 for your answer.
3. **CHALLENGE:** What does Romans 6:1,2 say about sinning?

Read Romans chapter 3, verses 9 - 20.

1. When the word “Jews” is written, Paul means the Jewish nation. When the word “Gentiles” is written, Paul means everyone who isn’t a Jew. How does Paul say Jews and Gentiles are the same?

The word “righteousness” means: “purity of heart; the state of being and doing right” (UNGER’S).

2. What does Isaiah 64:6 say about our righteousness?
3. **CHALLENGE:** Can anyone be righteous by only obeying the law?
4. What does James 2:10 say about obeying the Law?
5. We can’t clear away, or justify, our sins by ourselves. So how can our sins be cleared away, or justified? Use these verses for your answer.

Acts 13:38,39

Galatians 2:16

Read Romans chapter 3, verses 21 - 26.

1. Where do we get our right standing with God?
2. How did God do this to make us right in His eyes?
3. **HARD:** What does the law show us?

Read Romans chapter 3, verses 27 - 31.

1. Even though someone brags about doing everything the Ten Commandments say, they are not saved. How do these verses say a person is saved?

Romans 3:28

Ephesians 2:8,9

Galatians 3:24

2. If we have faith in Jesus, do we still have to obey God's Law? See Romans 3:31.
3. Which verse did you memorize?

ROMANS - WEEK FOUR

DISCUSSION LESSON THREE

15 - 20 minutes free time - games; fellowship

15 - 20 minutes snack and group recreation: CAR LOT

Evenly divide into groups. Each group calls themselves by a name of a car. Choose "It." Draw a starting line upon which all "cars" are to stand, and a finish line that must be reached before being tagged. "It" stands in center of the two lines and calls out a name of a car. That car group tries to reach the finish line before being tagged by "It." If tagged, they sit where tagged. They also may tag other runners from their sitting position. If "It" calls "Car Lot" everyone races to the finish line. Repeat game as many times as desired, choosing different players to be "It."

15 - 20 minutes discuss LESSON 3

to end of class CRAFT: NAPKIN HOLDER

MATERIALS

clean plastic detergent bottle
yarn

glue
scissors

Cut the bottle down to 4 1/2" high. Cut 3 1/2" from the narrow sides (ends) of this piece, to about 1" from the bottom of the bottle (round edges if desired). Coil up the yarn and glue it to both long sides of the bottle. Fill in around the circle with vertical loops of yarn. **OPTIONAL:** Or paint the bottle with a design. You may want to glue pictures to the painted or unpainted bottles.

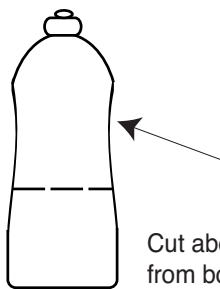

Cut about 4 1/2"
from bottom

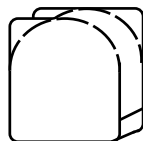

Round edges
if desired.



Coil yarn

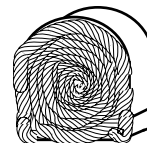

Glue coil to both
sides of bottle. Fill in
around the circle with
yarn.

ROMANS LESSON 3 ANSWERS

Read Romans chapter 2, verses 17 -29.

Verses 12-15 say: “He [God] will punish sin wherever it is found. The **heathen** never had God’s written laws. But he will punish them when they sin. Down in their hearts they know right from wrong. God’s laws are written within them. Their own heart accuses them, or sometimes excuses them. God will punish the Jews for sinning because they have his laws but don’t obey them. They know what is right but don’t do it. Salvation isn’t given to those who know what to do, unless they do it.”

1. What does Paul say about the Jews in verses 23,24? “You are **so proud of knowing God’s laws. But you shame him by breaking them.** No wonder the Bible says that the world speaks evil of God because of you.”
2. When Paul wrote this letter, the only Bible around was the Old Testament. What does Ezekiel 36:22 say the Jews did to God’s name? “Now say to the **people of Israel,** ‘The Lord God says: I am bringing you back again. But I am not doing it because you deserve it. I am doing it to protect my holy name. For **you have given me a bad name among the nations.**”
3. **HARD:** The Bible for Children, Simplified Living Bible Text says in Romans 2:29, “No, a real Jew is anyone whose heart is right with God. For God is not looking for those who cut their bodies in circumcision. He is looking for people with changed hearts and minds. Whoever has that kind of change will be praised not by you but by God.” What does this verse say is where the person whose heart and mind are changed gets praise? God.

Read Romans chapter 3, verses 1 - 8.

1. What does 2 Timothy 2:13 say about God’s faithfulness? “**When we are weak in faith, he is faithful to us.** He cannot disown us if we are a part of himself. He will always carry out his promises to us.”
2. What do some people think Paul is telling them? See Romans 3:8 for your answer. “But you are really saying, ‘The worse we are, the better God likes it!’ Some people say that this is what I preach! It is right that they be judged!”
3. **CHALLENGE:** What does Romans 6:1,2 say about sinning? “Should we keep on sinning! Will this make God give us more and more kindness and forgiveness? Of course not! Should we keep on sinning when we don’t have to? Sin’s power over us was broken.”

Read Romans chapter 3, verses 9 -20.

1. When the word “Jews” is written, Paul means the Jewish nation. When the word “Gentiles” is written, Paul means everyone who isn’t a Jew. How does Paul say Jews and Gentiles are the same? Verse 9: “Well, then, are we Jews better than others? No, not at all! We have already shown that **all people are sinners**. It doesn’t matter if they are Jews or Gentiles.”

The word “righteousness” means: “purity of heart; the being and doing right.” (UNGER’S)

2. What does Isaiah 64:6 say about our righteousness? “We are all infected and impure with sin. We put on our robes of righteousness, but we find **they are dirty rags**. Like the leaves in fall, we fade, dry up, and fall down. And our sins, like the wind, blow us away.”
3. **CHALLENGE:** Can anyone be righteousness by only obeying the law? See Romans 3:20 for your answer. “Now do you see it? No one can be right in God’s sight by doing what the law commands. The more we know God’s laws, the more we see that we aren’t obeying them. His laws only show us that we are sinners.”
4. What does James 2:10 say about obeying the Law? “What if someone keeps every law but makes one little slip? He is just as guilty as the person who has broken every law.”
5. **HARD:** We can’t clear away, or justify, our sins by ourselves. So, how can our sins be cleared away, or justified? Use these verses for your answer.

Acts 13:38,39 “Brothers! Listen! In this man Jesus there is forgiveness for your sins! Everyone who trusts in him is freed from all guilt. He is declared to be righteous and holy. This is something the Jewish law could never do.”

Galatians 2:16 “Yet we know that we can’t become right with God by obeying our Jewish laws. We know that our sins are forgiven only by faith in Jesus Christ. So we have trusted Jesus Christ, too. Now we are welcomed by God because of faith. He doesn’t welcome us because we obey the Jewish laws. For **no one will ever be saved by obeying them**.”

Read Romans chapter 3, verses 21 - 26.

1. Where do we get our right standing with God? Verses 21,22: “But now God has shown us another way to Heaven. It is not by “being good enough” and trying to keep his laws. It is by a new way. It is not really new. Because the Scriptures told about it long ago. Now God says he will accept us and declare us “not guilty.” He will do this if we trust Jesus Christ to take away our sins. We all can be saved by coming to Christ. It doesn’t matter who we are or what we have been like.”

2. How did God do this—make us right in His eyes? Verse 25: “God sent Christ Jesus to take the punishment for our sins. He ended all God’s anger against us. Christ’s blood and our faith saves us from God’s anger. This is the way he could be fair to everybody. He did not punish the people who sinned before Christ came. He was looking forward to the time when Christ would come and take away those sins.”
3. **HARD:** What does the law show us? Verse 20: “Now do you see it? No one can be right in God’s sight by doing what the law commands. The more we know God’s laws, the more we see that we aren’t obeying them. His laws only show us that we are sinners.”

Read Romans chapter 3, verses 27 - 31.

1. Even though someone brags about doing everything the Ten Commandments say, they are not saved. How do these verses say a person is saved?

Romans 3:28 “So we are saved by faith in Christ, not by the good things we do.”

Ephesians 2:8,9 “Because of his kindness, you have been saved through trusting Christ. And even that trust is not your own. It, too, is a gift from God. Salvation is not a reward for the good we have done. So none of us can take any credit for it.”

Galatians 3: 24 “Let me put it another way. The Jewish laws were our teacher and guide until Christ came. He gave us right standing with God through our faith.”

2. If we have faith in Jesus, do we still have to obey God’s Law? See Romans 3:31. “We are saved by faith. Does this mean that we no longer need to obey God’s laws? Just the opposite! In fact, only when we trust Jesus can we really obey him.”
3. Which verse did you memorize?

ROMANS - LESSON 4

Before you begin your lesson:

- a. Pray for God's Holy Spirit to help you answer the questions.
- b. Some questions may be too hard; it's ok to write "I don't know."
- c. Think about what God's Word is telling you for today.
- d. With some questions, it might be helpful to write the scripture verses on your paper.

Read Romans chapter 3, verses 25 - 31.

The meaning, or definition, of the following words come from The Holt Intermediate Dictionary of American English.

atonement: "a making amends for a wrong, crime, sin, etc."

amends: "to make up for harm or injury."

In the book of Genesis, we read about Noah, the ark, the flood, and the rainbow. God was so angry at how sinful the people were, that He wiped all of them out, except for Noah and his family. God always punishes sin. But, after the flood, He put a rainbow in the sky as a promise that He will not wipe out the world by a flood again. He had a different plan to clear up the sins of mankind.

1. What does Paul say is God's plan in Romans 3:25?

2. What does 2 Peter 3:9 tell you is God's reason for waiting for Jesus to come back to earth to wipe out sinners and the world?

Read Romans chapter 4, verses 1 - 8.

Paul knows the Jews in his day will have questions about salvation by faith alone. The Jews thought doing good and keeping the laws would save them. Many had misunderstood Abraham's obedience. They thought since he obeyed God, he was righteous. In Romans 4:1-3 Paul proves it was Abraham's faith that made him right in God's eyes.

James 2:21,22 gives more information about Abraham's faith. It says: "Remember, our father Abraham was declared good because of what he did. He was willing to obey God. He even went as far as giving his son Isaac to die on the altar. He had enough faith to do whatever God told him. His faith was made complete by what he did."

1. Because Abraham trusted God, what does James 2:23 say that Abraham was called?

2. Everyone likes to be noticed for the good things he does. But, that doesn't get God's attention. What does 1 Samuel 16:7b say gets God's attention?

3. **CHALLENGE:** You might get an allowance for doing chores around the house. But, if you get money for no reason, what is that called?

4. **HARD:** What does Paul call faith in Ephesians 2:8,9?

5. When we sin, we feel guilty about what we have done until we confess our sin and ask God's forgiveness. In Romans 4:7,8 Paul repeats what David wrote in Psalm 32:1,2. What does Psalm 103:12 tell you about God's forgiveness?

6. **PERSONAL:** Have you confessed your sin to God and asked His forgiveness? Have you accepted God's gift of salvation through faith and trust in Jesus Christ to save you? You can't have a right standing before God by being good or doing good things. Why not confess your sin, thank God for His forgiveness through Jesus Christ, and accept His gift of righteousness right now?

Read Romans chapter 4, verses 9 - 17.

1. Paul asked, “When did God bless Abraham?” How does Paul answer his own question in verse 10b?
2. What does Paul say circumcision is?
3. What did Abraham do to receive God’s promise?
4. How much do God’s blessings cost?

Read Romans chapter 4, verses 18 - 25.

1. What did God tell Abraham in verse 18?
2. What did Abraham do even though God’s promise seemed impossible?
3. Did God do this just for Abraham? Why?

4. God has given us many promises in the Bible. Here are just a few, there are many more. Some Bibles have a Dictionary, an Index to Subjects, or a Concordance in the back. If there is a promise that you need which isn't on this very small list, use the references at the back of your Bible to help you.

ANGER

James 1:19 “Dear Brothers, remember this! It is best to listen much, speak little, and not become angry.”

BELIEF

John 3:36 “And all who trust God’s Son to save them have eternal life. Those who don’t believe and obey him will never see life. But the anger of God will stay upon them.”

COURAGE

1 John 4:4 “Dear young friends, you belong to God. You have already won your fight with those who are against Christ. There is someone in you who is stronger than any evil teacher in this world.”

FAITH

Galatians 3:26 “Now we are all children of God through faith in Jesus Christ.”

GUIDANCE

Psalm 32:8 “‘I will teach you,’ says the Lord. ‘I will guide you along the best path for your life. I will advise you and watch your progress.’”

HELP

Psalm 46:1 “God is our refuge and strength, an ever-present help in trouble.” (NIV)

LONELINESS

John 14:18 “‘No, I will not abandon you or leave you as orphans. I will come to you.’”

OBEDIENCE

John 15:10 “‘When you obey me you are living in my love. In the same way, I obey my Father and live in his love.’”

SALVATION

Romans 10:9 “This is how you will be saved. Tell others with your own mouth that Jesus Christ is your Lord. Also, believe in your own heart that God has raised him from the dead.”

TRUST

Proverbs 3:5,6 “If so, then trust the Lord with all your heart. Don’t ever trust yourself. In all you do, put God first. He will direct you and crown your efforts with success.”

ROMANS - WEEK FIVE

DISCUSSION LESSON FOUR

15 - 20 minutes free time - games; fellowship

15 - 20 minutes snack and group recreation: KNEE RELAYS

Play this as a team relay game. The first player from each team puts a book between his knees and rushes off around the room (one clockwise, one counterclockwise). A dropped book means going back to the start. Hands may be used only during a changeover from one player to another within a team. Try the game with a big, heavy book and then with a slim, light paperback. Which is easier? The team that finishes first wins.

15 - 20 minutes discuss LESSON 4

to end of class CRAFT: FILMSTRIP VIEWER

MATERIALS

empty paper towel tube
time line picture (next page) or have class make its own time line
crayons, colored pencils
sharp knife
tape or glue
craft stick

Filmstrip should be about 1-1/2 inches wide, 10 or more inches long. Color, or draw if making own time line pictures. Tape pictures together to make one long strip. Cut a 2- to 2-1/2 inch piece off the end of the paper towel tube. Put the two sections back together again with a slight space between cut ends. Glue the craft stick along the tube across the cut space to hold sections together. Put the paper in the slot, resting on the craft stick. Hold up to the light and look through the end farthest away from the slot, pulling the filmstrip through.

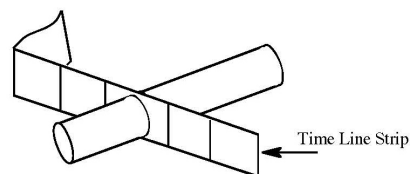
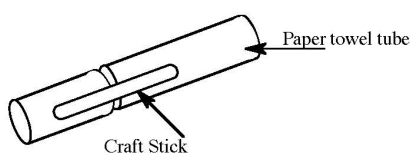

1. **400 YEARS BETWEEN THE TESTAMENTS**

BC/AD

JESUS' BAPTISM

26 AD

2.

THE LAST SUPPER

CRUCIFIXION

RESURRECTION

3. **30 AD**

ASCENSION

PENTECOST

PERSECUTION OF APOSTLES

SAUL

35 AD

PETER

5.

SHIPWRECK



PAUL IN ROME



60AD

90 AD

JOHN



95 AD

A vertical timeline for the year 5. It features a thick black horizontal line. Above the line, from left to right, are three illustrations: a shipwreck with a man in a boat (labeled 'SHIPWRECK'), Paul writing at a desk (labeled 'PAUL IN ROME'), and John writing at a desk (labeled 'JOHN'). Below the line, from left to right, are the dates '60AD', '90 AD', and '95 AD'. The number '5.' is at the top left.

5.

SHIPWRECK



PAUL IN ROME



60AD

90 AD

JOHN



95 AD

A vertical timeline for the year 5. It features a thick black horizontal line. Above the line, from left to right, are three illustrations: a shipwreck with a man in a boat (labeled 'SHIPWRECK'), Paul writing at a desk (labeled 'PAUL IN ROME'), and John writing at a desk (labeled 'JOHN'). Below the line, from left to right, are the dates '60AD', '90 AD', and '95 AD'. The number '5.' is at the top left.

ROMANS LESSON 4 ANSWERS

Read Romans chapter 3, verses 25 - 31.

The meaning, or definition, of the following words come from The Holt Intermediate Dictionary of American English.

atonement: “a making amends for a wrong, crime, sin, etc.”

amends: “to make up for harm or injury.”

In the book of Genesis, we read about Noah, the ark, the flood, and the rainbow. God was so mad at how sinful the people were, that He wiped all of them out, except for Noah and his family. God always punishes sin. But, after the flood, He put a rainbow in the sky as a promise that He will not wipe out the world by flood again. He had a different plan to clear up the sins of mankind.

1. What does Paul say is God’s plan in Romans 3:25? “God sent Christ Jesus to take the punishment for our sins. He ended all God’s anger against us. Christ’s blood and our faith saves us from God’s anger. This is the way he could be fair to everybody. He did not punish the people who sinned before Christ came. He was looking forward to the time when Christ would come and take away those sins.” [In other words, the death of Jesus Christ paid the punishment for all the sins of the people before Him, and those who come after Him. An illustration would be to picture rain coming down on a hill and forming a small pool, right in the middle of the hill. Soon, the pool would fill with water. The water would overflow its banks. It would spill out, and roll down both sides of the hill. If we think one side of the hill as being those people who lived before Christ, and the other side as people who lived after Christ, both would receive water. That is a simple picture of salvation before and after Jesus Christ.]
2. What does 2 Peter 3:9 tell you is God’s reason for waiting for Jesus to come back to earth to wipe out sinners and the world? “It may seem like he is slow in coming back as he promised. But he isn’t. He is waiting because he does not want anyone to die. He is giving more time for sinners to repent.”

Read Romans chapter 4, verses 1 - 8.

Paul knows the Jews in his day will have questions about salvation by faith alone. The Jews thought they would be saved by doing good and keeping the laws. Many had misunderstood Abraham’s obedience. They thought since he obeyed God, he was righteous. In Romans 4:1-3 Paul proves it was Abraham’s faith that made him right in God’s eyes.

James 2:21,22 gives more information about Abraham's faith. It says: "Remember, our father Abraham was declared good because of what he did. He was willing to obey God. He even went as far as giving his son Isaac to die on the altar. He had enough faith to do whatever God told him. His faith was made complete by what he did."

1. Because Abraham trusted God, what does James 2:23 say that Abraham was called? "So it happened just as the Bible says. Abraham trusted God, and the Lord declared him good. He was even called 'the friend of God.'"
2. Everyone likes to be noticed for the good things he does. But, that doesn't get God's attention. What does 1 Samuel 16:7b say gets God's attention? "I don't make decisions the way you do! People accept others by the way they look on the outside. But I look inside a person. I look at a person's heart and thoughts."
3. **CHALLENGE:** You might get an allowance for doing chores around the house. But, if you get money for no reason, what is that called? A gift.
4. **HARD:** What does Paul call faith in Ephesians 2:8,9? "Because of his kindness, you have been saved through trusting Christ. And even that trust is not your own. It, too, is a gift from God. Salvation is not a reward for the good we have done. So none of us can take any credit for it."
5. When we sin, we feel guilty about what we have done until we confess our sin and ask God's forgiveness. In Romans 4:7,8 Paul repeats what David wrote in Psalm 32:1,2. What does Psalm 103:12 tell you about God's forgiveness? "He has taken our sins far away from us. He has taken them as far as the east is from the west."
6. **PERSONAL:** Have you confessed your sin to God and asked His forgiveness? Have you accepted God's gift of salvation through faith and trust in Jesus Christ to save you? You can't have a right standing before God by being good or doing good things. Why not confess your sin, thank God for His forgiveness through Jesus Christ, and accept His gift of righteousness right now?

Read Romans chapter 4, verses 9 - 17.

1. Paul asked "When did God bless Abraham?" How does Paul answer his own question in verse 10b? "It was before he became a Jew. It was before he was circumcised."
2. What does Paul say circumcision is? Verse 11: "After God had promised to bless him because of his faith, he was circumcised. Circumcision was a sign that Abraham already had faith. It showed that God had already accepted him. God said he was just and good in his sight before he was circumcised. So Abraham is the spiritual father of people who believe. They are saved without obeying Jewish laws. People who do not keep these rules are justified by God because of faith."

3. What did Abraham do to receive the God's promise? Verse 13: "God promised to give the whole earth to Abraham and his children. God's promise was not because Abraham obeyed God's laws. It was because Abraham trusted God to keep his promise."
4. How much do God's blessings cost? Verse 16: "So God's blessings are a free gift. They are given to us by faith. We will get them if we follow Jewish customs. And we will get them if we have faith like Abraham's. Because Abraham is the father of all of us who have faith."

Read Romans chapter 4, verses 18 - 25.

1. What did God tell Abraham in verse 18? "God told Abraham that he would give him a son. That son would have many children and become a great nation. Abraham believed God even though such a promise just couldn't happen!"
2. What did Abraham do even though God's promise seemed impossible? Verses 20,21: "But Abraham never doubted. His faith and trust always grew stronger. So he praised God for this blessing even before it happened. He was sure that God was able to do anything he promised."
3. Did God do this just for Abraham? Why? No. Verse 24: "It was for us too. We believe in God who brought back Jesus our Lord from the dead. So God will accept us the same way he accepted Abraham."
4. God has given us many promises in the Bible. Here are just a few, there are many more. Some Bibles have a Dictionary, an Index to Subjects, or a Concordance in the back. If there is a promise that you need which isn't on this very small list, use the references at the back of your Bible to help you.

ANGER

James 1:19 "Dear Brothers, remember this! It is best to listen much, speak little, and not become angry."

BELIEF

John 3:36 "And all who trust God's Son to save them have eternal life. Those who don't believe and obey him will never see life. But the anger of God will stay upon them."

COURAGE

1 John 4:4 "Dear young friends, you belong to God. You have already won your fight with those who are against Christ. There is someone in you who is stronger than any evil teacher in this world."

- FAITH** Galatians 3:26 “Now we are all children of God through faith in Jesus Christ.”
- GUIDANCE** Psalm 32:8 “‘I will teach you,’ says the Lord. ‘I will guide you along the best path for your life. I will advise you and watch your progress.’”
- HELP** Psalm 46:1 “God is our refuge and strength, an ever-present help in trouble.” (NIV)
- LONELINESS** John 14:18 “‘No, I will not abandon you or leave you as orphans. I will come to you.’”
- OBEDIENCE** John 15:10 “‘When you obey me you are living in my love. In the same way, I obey my Father and live in his love.’”
- SALVATION** Romans 10:9 “This is how you will be saved. Tell others with your own mouth that Jesus Christ is your Lord. Also, believe in your own heart that God has raised him from the dead.”
- TRUST** Proverbs 3:5,6 “If so, then trust the Lord with all your heart. Don’t ever trust yourself. In all you do, put God first. He will direct you and crown your efforts with success.”

JOY OF LIVING

ROMANS - LESSON 5

Before you begin your lesson:

- a. Pray for God's Holy Spirit to help you answer the questions.
- b. Some questions may be too hard; it's ok to write "I don't know."
- c. Think about what God's Word is telling you for today.
- d. With some questions, it might be helpful to write the scripture verses on your paper.

Read Romans chapter 5, verses 1 - 5.

1. You may hear the word "justify" or justified often. Using your dictionary, what is the meaning of the word "justify"?

2. What did Jesus say about Himself in John 14:6?

3. **HARD:** What does Colossians 1:21 tell us is the reason we need Jesus to meet with God?

4. Below is listed "faith, hope, love". Match these words with the sentence that describes them.

faith	a Christian rejoices in the promises God has given, the promise of eternal life.
hope	given by God into the hearts of Christians.
love	gives us peace with God; with it, we believe we are clean from past sins through the blood of Jesus Christ.

5. Sometimes Christians have bad and hurtful things happen to them. What does Romans 5:3,4 say grows in the Christian?

6. Paul had bad and hurtful things happen to him. What does 1 Thessalonians 2:2 say that proves he never turned away from trusting God?
7. Sometimes, Christians wonder why bad things happen. Sometimes, they might get mad at God. But, God uses these bad things to help them grow to be like Jesus. What do these verses say will help when bad, sad, and hurtful things happen to you?

Philippians 1:6

1 John 3:2b

Read Romans chapter 5, verses 6 - 11.

In this next section, you will do a little math. When you do the math, you will know what letter to put in the space above the numbers. The space without any numbers under it is for your name. Be sure to put your name in that space. This math problem will help explain verses 6-11. **NOTE:** It might be helpful to put your name in the spaces first. Then, do a simple math problem, and find all the numbers that are like your answer and put the correct letter in the space above it. Fill in all the spaces with that number. You might be able to guess the answer before you have completed the math. The first word is done for you.

- | | |
|---------------------------|------------------------|
| A. $1 + 1 =$ | N. $6 \times 6 =$ |
| B. $4 + 5 =$ | O. $125 + 125 =$ |
| C. $2 \times 2 =$ | P. $14 - 7 =$ |
| D. $17 + 2 =$ | Q. $18 - 3 =$ |
| E. $25 - 20 =$ | R. $45 - 9 \times 2 =$ |
| F. $63 + 27 =$ | S. $475 + 9 + 25 =$ |
| G. $24 \times 6 =$ | T. $33 + 33 + 34 =$ |
| H. $12 + 72 =$ | U. $84 + 26 =$ |
| I. $12 - 9 =$ | V. $14 \times 2 =$ |
| J. $15 \times 7 =$ | W. $4 \times 2 =$ |
| K. $115 - 14 =$ | X. $11 + 19 - 3 =$ |
| L. $50 - 25 =$ | Y. $14 + 86 + 123 =$ |
| M. $7 + 14 + 3 + 6 - 8 =$ | Z. $97 - 22 =$ |

S I N K E P T A W A Y F R O M G O D.
 509 3 36 101 5 7 100 2 8 2 223 90 72 250 22 144 250 19

_____ 8 2 509 144 250 19 509 5 36 5 22 223 9 110 100

144 250 19 509 5 36 100 105 5 509 110 509 100 250 100 2 101 5 100 84 5

7 110 36 3 509 84 22 5 36 100 90 250 72 _____ 509 509 3 36

_____ 36 250 8 100 72 110 509 100 509 105 5 509 110 509 100 250

22 2 101 5 _____ 144 250 19 509 90 72 3 5 36 19

Read Romans chapter 5, verses 12 - 17.

1. What does God say about His creation in Genesis 1:31?

2. Read Genesis 3: 1-7,17. How did Adam bring sin into the world?

3. What else happened because Adam sinned? See Romans 5:12-17.

4. What does Romans 6:23 say is the gift of God that Jesus gave?

5. **CHALLENGE:** What do these verses say is the way to get God's gift?

John 1:12

1 John 1:9

6. **PERSONAL:** Do you have God's gift of life never ending? Do you want it? Just do what 1 John 1:9 and John 1:12 tells you to do. You will then have eternal life through Jesus Christ.

Read Romans chapter 5, verses 18 - 21.

1. **RISKY:** One man through his sin, brought death to all men. One man through his death, brought forgiveness and eternal life. Who are these two men?
2. What does 1 John 1:8 say about sin?
3. **HARD:** *The Simplified Living Bible Text*, Romans 5:20 says: "God's laws were given so that everybody could know how much they had failed. But the more we see our sin, the more we see God's grace forgiving us." According to this verse, why were God's laws given?
4. **PERSONAL:** Which verse have you memorized to help you remember how God wants you to live?

ROMANS - WEEK SIX

DISCUSSION LESSON FIVE

15 - 20 minutes free time - games; fellowship

15 - 20 minutes snack and group recreation: CARD TOSS

You will need a hat and a deck of cards. Mark the START line from which the cards will be tossed. Place the hat about five feet from the line. In turn, each player will have a chance to throw the 52 cards and try to get them into the hat. The player with the most cards in the hat wins.

15 - 20 minutes discuss LESSON 5

to end of class CRAFT: HOMEMADE WATER COLORS

MATERIALS

1 tbs. Baking soda
1/2 cup white (clear) vinegar
1/2 cup cornstarch
2 tsp. Corn syrup

food coloring
plastic lids, minimum of 3
paint brushes
1 bowl
paper for painting

Mix the vinegar and baking soda in the bowl. This will fizz. Add the cornstarch and corn syrup when fizzing stops. Then blend the ingredients together. You will have a cake-like consistence. Divide the mixture into the 3 plastic lids, or more as desired. With the paint brush, blend a few drops of food coloring into each mixture. Be creative and mix some of the colors as well as using one color per mixture. For brighter colors, use more food coloring. You can use immediately, or allow to dry into cakes. Then swirl a wet paint brush into a cake and begin painting.

ROMANS LESSON 5 ANSWERS

Read Romans chapter 5, verses 1 - 5.

1. You may hear the word “justify” or justified often. Using your dictionary, what is the meaning of the word “justify”? “To show to be right or just; defend with good reason. To declare free from blame.” (HOLT)
2. What did Jesus say about Himself in John 14:6? “Jesus said, ‘I am the Way, the Truth, and the Life. No one can get to the Father except through me.’”
3. **HARD:** What does Colossians 1:21 tell us is the reason we need Jesus to meet with God? “This includes you who were once so far away from God. You were his enemies and hated him. You were separated from him by your evil thoughts and actions. Yet now he has brought you back as his friends.” [God is holy. He cannot stand to look at sin. He wants to have fellowship with us, so He made a way for that to happen. He did it all. We don’t have to do anything except accept what He has done for us to “declare us free from blame.” We cannot keep the whole Law, we are not righteous, but Jesus is. He lived a totally righteous life. He was in fellowship with God and took the punishment we deserve. That is why only through trusting and believing in Him, we can come to God.]
4. Below is listed “faith, hope, love”. Match these words with the sentence that describes them.

faith	<u>gives us peace with God; with it, we believe we are clean from past sins through the blood of Jesus Christ.</u>
hope	<u>a Christian rejoices in the promises God has given, the promise of eternal life.</u>
love	<u>given by God into the hearts of Christians</u>
5. Sometimes Christians have bad and hurtful things happen to them. What does Romans 5:3,4 say grows in the Christian? “Here we can rejoice when we run into problems and trials. We know that they are good for us. They help us learn to be patient. And patience helps us become better people. This helps us trust God. Finally our hope and faith are strong and steady.”
6. Paul had bad and hurtful things happen to him. What does 1 Thessalonians 2:2 say that proves he never turned away from trusting God? “You know how badly we were treated at Philippi just before we came. You know how much we suffered there. Yet God gave us the courage to boldly repeat the same message to you. We did this even though we were surrounded by enemies.”

7. Sometimes, Christians wonder why bad things happen. Sometimes, they might get mad at God. But, God uses these bad things to help them grow to be like Jesus. What do these verses say will help when bad, sad, and hurtful things happen to you?

Philippians 1:6 “God began the good work within you. I am sure he will finish it until Jesus Christ comes back.”

1 John 3:2b “But we do know that when he comes we will be like him. We shall see him as he really is.”

Read Romans chapter 5, verses 6 - 11.

In this next section, you will do a little math. When you do the math, you will know what letter to put in the space above the numbers. The space without any numbers under it is for your name. Be sure to put your name in that space. This math problem will help explain verses 6-11. **NOTE:** It might be helpful to put your name in the spaces first. Then, do a simple math problem, and find all the numbers that are like your answer and put the correct letter in the space above it. Fill in all the spaces with that number. You might be able to guess the answer before you have completed the math. The first word is done for you.

- A. $1 + 1 = 2$
- B. $4 + 5 = 9$
- C. $2 \times 2 = 4$
- D. $17 + 2 = 19$
- E. $25 - 20 = 5$
- F. $63 + 27 = 90$
- G. $24 \times 6 = 144$
- H. $12 + 72 = 84$
- I. $12 - 9 = 3$
- J. $15 \times 7 = 105$
- K. $115 - 14 = 101$
- L. $50 - 25 = 25$
- M. $7 + 14 + 3 + 6 - 8 = 22$
- N. $6 \times 6 = 36$
- O. $125 + 125 = 250$
- P. $14 - 7 = 7$
- Q. $18 - 3 = 16$
- R. $45 - 9 \times 2 = 72$
- S. $475 + 9 + 25 = 509$
- T. $33 + 33 + 34 = 100$
- U. $84 + 26 = 110$
- V. $14 \times 2 = 28$
- W. $4 \times 2 = 8$
- X. $11 + 19 - 3 = 27$
- Y. $14 + 86 + 123 = 223$
- Z. $97 - 22 = 75$

S	I	N	K	E	P	T	_____	A	W	A	Y	F	R	O	M	G	O	D.		
509	3	36	101	5	7	100		2	8	2	223	90	72	250	22	144	250	19		
_____			W	A	S	G	O	D	'	S	E	N	E	M	Y.	B	U	T		
			8	2	509	144	250	19	509	5	36	5	22	223	9	110	100			
G	O	D	S	E	N	T	J	E	S	U	S	T	O	T	A	K	E	T	H	E
144	250	19	509	5	36	100	105	5	509	110	509	100	250	100	2	101	5	100	84	5
P	U	N	I	S	H	M	E	N	T	F	O	R	_____	'	S	S	I	N.		
7	110	36	3	509	84	22	5	36	100	90	250	72			509	509	3	36		
_____			N	O	W	T	R	U	S	T	S	J	E	S	U	S	T	O		
			36	250	8	100	72	110	509	100	509	105	5	509	110	509	100	250		
M	A	K	E	_____	G	O	D	'	S	F	R	I	E	N	D.					
22	2	101	5		144	250	19	509	90	72	3	5	36	19						

Read Romans chapter 5, verses 12 - 17.

1. What does God say about His creation in Genesis 1:31? “Then God looked over all that he had made. It was excellent in every way. This ended the sixth day.”
2. Read Genesis 3:1-7,17. How did Adam bring sin into the world? Verses 6, 17. Verse 6: “The woman was convinced. How lovely and fresh-looking it was! And it would make her so wise! So she ate some of the fruit and gave some to her husband. He ate it too.” Verse 17: “And God said to Adam, ‘You listened to your wife. You ate the fruit when I told you not to. Therefore I have placed a curse upon the soil. All your life you will work hard to extract a living from it.’”
3. What else happened because Adam sinned? See Romans 5:12-17. “When Adam sinned, sin entered the whole human race. His sin spread death through all the world. Everything began to grow old and die because all sinned.”
4. What does Romans 6:23 say is the gift of God that Jesus gave? “Sin makes us die. Through Christ, God gives us life that never ends.”
5. **CHALLENGE:** What do these verses say is the way to get God’s gift?

John 1:12 “But to all who received him, he gave the right to become God’s children. All they needed to do was to believe in him.”

1 John 1:9 “If we confess our sins, he can be depended on to forgive us. He will cleanse us from every wrong. It is proper for God to do this because Christ died for our sins.”

6. **PERSONAL:** Do you have God’s gift of life never ending? Do you want it? Just do what 1 John 1:9 and John 1:12 tells you to do. You will then have eternal life through Jesus Christ.

Read Romans chapter 5, verses 18 - 21.

1. **RISKY:** One man through his sin, brought death to all men. One man through his death, brought forgiveness and eternal life. Who are these two men? Verse 18: “Yes, Adam’s sin brought punishment to all. But what Christ did was right and good. This makes men right with God, so that they can live.”
2. What does 1 John 1:8 say about sin? “If we say that we have no sin, we are fooling ourselves. We are refusing to accept the truth.”
3. **HARD:** The Simplified Living Bible Text, Romans 5:20 says: “God’s laws were given so that everybody could know how much they had failed. But the more we see our sin, the more we see God’s grace forgiving us.” According to this verse, why were God’s laws given? So we could know when we sinned.
4. **PERSONAL:** Which verse have you memorized to help you remember how God wants you to live?

ROMANS - LESSON 6

Before you begin your lesson:

- a. Pray for God's Holy Spirit to help you answer the questions.
- b. Some questions may be too hard; it's ok to write "I don't know."
- c. Think about what God's Word is telling you for today.
- d. With some questions, it might be helpful to write the scripture verses on your paper.

Read Romans chapter 6, verses 1 - 14.

1. How does Paul answer his question, "Should we keep on sinning? Will this make God give us more and more kindness and forgiveness?"

2. Jesus never sinned. He obeyed His Father. It is hard for you not to sin, but, when Jesus lives in your heart, His Holy Spirit helps you not to sin. But you must ask Him to help you. What do these verses say that show you God wants to help you obey Him?

Philippians 2:13

Philippians 4:13

3. When someone becomes a Christian, he/she has asked forgiveness from God for the sins he/she kept doing over and over again. Romans 6:6 says, "Your old evil desires were nailed to the cross with him. The part of you that loves to sin was crushed. Now your sin-loving body is no longer under sin's control. It no longer needs to be a slave to sin." But, Christians do sin, even when they don't want to. What does 1 John 1:9 say a Christian needs to do each time he/she sins?

4. What promises are given to the Christian in these verses?

Romans 6:5

2 Corinthians 5:17

5. What does Paul say about Jesus Christ in Romans 6:9,10?
6. What does Hebrews 9:27,28 say about man's death?
7. Where is Jesus now? See Mark 16:19 for your answer.
8. What is Paul's warning about in Romans 6:12?
9. **RISKY:** This question has two parts, but one verse answers both questions. When God created man, He made his body with many parts. Every part of the body has a job to do. Which part of the body is it okay for sin to control? Which part of the body should be given to God to control?
10. What does Galatians 5:19-21a say is sin?
11. **CHALLENGE:** What trouble can these parts of the body get into and cause you to sin?

brain

mouth

eyes

ears

nose

arms, hands

stomach

legs/feet

Read Romans chapter 6, verses 15 - 23.

Sometimes we use words that we aren't sure of their meaning. The following words we use often. When you read what they mean, you may better understand what Paul is saying.

grace "Unmerited divine assistance given man for regeneration or sanctification." (WEBSTER'S) Or, we don't get the punishment for our sins that we should get.

mercy "Compassion or forbearance shown to an offender or subject." (WEBSTER'S) Or, we get God's love and forgiveness that we don't have the right to get.

obedient "Obeying orders, rules, etc.; submitting to the command or will of others." (HOLT)

righteous "Doing what is right; virtuous; justified." (HOLT) [Virtuous: "having moral excellence."]

sin "The breaking or violation of God's laws in act or thought." (HOLT)

slave "Person who is owned by or completely under the control of someone else." (HOLT)

1. If you are a slave to sin, what do you get? Give verse.
2. If you are a slave to obedience, what do you get? Give verse.
3. **CHALLENGE:** What does Paul say the Christian is set free from and is a slave to?
4. **HARD:** What is the payment for sin, and the gift of God?

ROMANS - WEEK SEVEN

DISCUSSION LESSON SIX

15 - 20 minutes free time - games; fellowship

15 - 20 minutes snack and group recreation: CHAIN TAG

Two players are chosen to be “IT.” They join hands and with their free hand try to tag the other players. Players avoid being tagged. The first player tagged joins hands between the two “IT.” The remaining players, when they are tagged, join the tag line between the original two “IT.” Only end players (IT) may tag. It is permissible for a player to break through or go under the joined hands of the line. When the chain has been broken, it must unite again before tagging resumes. The game ends when the last player is caught or when a time limit has been reached. The last two players tagged become “IT.” Set boundary lines to restrict play area.

15 - 20 minutes discuss LESSON 6

to end of class CRAFT: TILE MAGNET

MATERIALS

small (1 to 1-1/2”) white ceramic tiles (from hardware or paint store)
small (1/2” or less) Christian stickers
magnetic squares or tapes (from craft store)
paint & brushes
Mod Podge or shellac
glue

Paint the tile, or leave white. Allow to dry. Paint a small picture, word, or any design onto the small ceramic tile. Allow to dry. Stick small Christian sticker on tile, if there is room. Cover with a coat of Mod Podge or shellac. Allow to dry. When dry, glue magnet strip or square onto back.

ROMANS LESSON 6 ANSWERS

Read Romans chapter 6, verses 1 - 14.

1. How does Paul answer his question, “Should we keep on sinning? Will this make God give us more and more kindness and forgiveness?” Verses 2,3: “Of course not! Should we keep on sinning when we don’t have to? Sin’s power over us was broken. This happened when we were baptized to become a part of Jesus Christ. Through his death the power of your sinful nature was broken.” [The baptism spoken of here is not that of water baptism, but of the Holy Spirit coming to live in the believer. This is a word picture. When someone is dirty, they take a bath or shower to get clean. Before they get wet, they are dirty; after they are washed they are clean. Likewise, when someone is immersed in water, they go under the water and come up out of the water clean. Another word picture is Jesus’ burial and resurrection. The going under the water is the burial, the getting up out of the water is His resurrection. It is a symbolic word picture. The thought that more sin would give more forgiveness is taking God for granted. It would be as if a Christian planned to steal something from a store, knowing if they confessed the theft God would forgive. If we know we are doing something wrong but continue doing it, knowing we are going to confess it later, our confession and sadness over our sin is only half sincere.]
2. Jesus never sinned. He obeyed His Father. It is hard for you not to sin, but, when Jesus lives in your heart, His Holy Spirit helps you not to sin. But you must ask Him to help you. What do these verses say that show you God wants to help you obey Him?

Philippians 2:13 “For God is at work within you. He helps you want to obey him. And he helps you do what he wants.”

Philippians 4:13 “I can do everything God asks me to with the help of Christ. He gives me strength and power.”

3. When someone becomes a Christian, he/she has asked forgiveness from God for the sins he/she kept doing over and over again. Romans 6:6 says, “Your old evil desires were nailed to the cross with him. The part of you that loves to sin was crushed. Now your sin-loving body is no longer under sin’s control. It no longer needs to be a slave to sin.” But, Christians do sin, even when they don’t want to. What does 1 John 1:9 say a Christian needs to do each time he/she sins? “If we confess our sins, he can be depended on to forgive us. He will cleanse us from every wrong. It is proper for God to do this because Christ died for our sins.”

4. What promises are given to the Christian in these verses?

Romans 6:5 “You have become a part of him. So you died with him, so to speak, when he died. Now you share his new life and will rise as he did.”

2 Corinthians 5:17 “When someone becomes a Christian, he becomes a brand new person inside. He is not the same anymore. A new life has begun!”

5. What does Paul say about Jesus Christ in Romans 6:9,10? “Christ rose from the dead and will never die again. Death no longer has any power over him. He died once for all to end sin’s power. But now he lives forever in fellowship with God.”

6. What does Hebrews 9:27,28 say about man’s death? “It is planned that men die only once. And after that comes judgment. So Christ died only once as an offering for the sins of many people. He will come again, but not to deal again with our sins. This time he will come to rescue all who are waiting for him.”

7. Where is Jesus now? See Mark 16:19 for your answer. “When Jesus had finished talking with them, he was taken up into Heaven. And there he sat down at God’s right hand.”

8. What is Paul’s warning in Romans 6:12? “Do not let sin control your body anymore. Do not give in to its sinful desires.”

9. **RISKY:** This question has two parts, but one verse answers both questions. When God created man, He made his body with many parts. Every part of the body has a job to do. Which part of the body is it okay for sin to control? Which part of the body should be given to God to control? Verse 13: “Do not let any part of your bodies become tools of wickedness. Do not let them be used for sinning. Give every part of yourself to God. You are back from death. Give yourself to be a tool in the hands of God. Let him use you for his good purposes.”

10. What does Galatians 5:19-21a say is sin? “But when you follow your own natural desires there will be evil results. There are impure thoughts, lustful pleasures, idolatry, spiritism, hatred, and fighting. There are jealousy and anger, arguments and criticism. People feel that everyone else is wrong except those in their own little group. There will be wrong doctrine, envy, and murder. People will get drunk at wild parties and do all these sorts of things.”

11. **CHALLENGE:** What trouble can these parts of the body get into and cause you to sin?

brain evil thoughts, plans, schemes, etc.

mouth unkind words; gossip; swear words; hateful words; sassy words, etc.

eyes violent movies, television; video games; computers; books; magazines, etc.

ears	<u>gossip; jokes that make fun of people or use bad language; music that isn't pleasing to God, or that suggests violence or cruelty, etc.</u>
nose	<u>sniffing drugs, etc.</u>
arms, hands	<u>fighting; hanging onto something that does not belong to you; stealing.</u>
stomach	<u>not eating right.</u>
legs/feet	<u>following the wrong person or crowd, doing things "every one else is doing" you know are wrong, etc.</u>

[Open this up for discussion. The class may come up with ideas and situations of their own.]

Read Romans chapter 6, verses 15 - 23.

1. Using your dictionary, what do these words mean?

obedient	“Obeying orders, rules, etc.; submitting to the command or will of others.” (HOLT)
righteous	“Doing what is right; virtuous; justified.” (HOLT) [Virtuous: “having moral excellence.”]
sin	“The breaking or violation of God’s laws in act or thought.” (HOLT)
slave	“Person who is owned by or completely under the control of someone else.” (HOLT)

2. If you are a slave to sin, what do you get? Give verse. Death, verse 16.

3. If you are a slave to obedience, what do you get? Give verse. Righteousness, verse 16.

4. **CHALLENGE:** What does Paul say the Christian is set free from and is a slave to? Verse 22: “But now you are free from the power of sin. You are slaves of God. So you will have holiness and everlasting life.”

5. **HARD:** What is the payment for sin, and the gift of God? Verse 23: “For the wages of sin is death, but the gift of God is eternal life in Christ Jesus our Lord” (NIV).

ROMANS - LESSON 7

Before you begin your lesson:

- a. Pray for God's Holy Spirit to help you answer the questions.
- b. Some questions may be too hard; it's ok to write "I don't know."
- c. Think about what God's Word is telling you for today.
- d. With some questions, it might be helpful to write the scripture verses on your paper.

Read Romans chapter 7, verses 1 - 6.

1. Some of Paul's readers know the law. What do these verses say about the Law?

Romans 5:20

Galatians 3:24

James 2:10

In Exodus 20:2-17 we find the Ten Commandments. These Commandments are the most important part of the Law God gave to Moses. There are other laws in the books of Leviticus and Deuteronomy. For now, we will look at the Ten Commandments. Verse 2 says God freed the Israelites from slavery in Egypt. Just as Paul says, in this chapter and throughout the entire book of Romans, we are freed from the slavery of sin. The Ten Commandments are listed below. Read them so you will remember what they are, and to understand the questions in this lesson.

1. "Do not worship any other god but me."
2. "You shall not make any idols. Make no images of animals, birds, or fish. You must never bow or worship an idol in any way. For I, the Lord your God, want you to be mine. I will not share your love with any other god!"
3. You shall not use the name of the Lord your God irreverently. Nor shall you use it to swear. You will not escape punishment if you do."
4. "Remember to observe the Sabbath as a holy day. Six days a week are for your daily duties and your regular work. But the seventh day is a day of Sabbath rest before the Lord your God."
5. "Honor your father and mother. Do this that you may have a long, good life in the land the Lord your God will give you."

6. "You must not murder."
 7. "You must not commit adultery."
 8. "You must not steal."
 9. "You must not lie."
 10. "You must not envy your neighbor's house. You must not want to sleep with his wife. You must not want to own his slaves, oxen, donkeys, or anything else he has."
2. When we break God's law, we sin. We are not right with God. What does Galatians 2:16 say is the way to get right with God?
3. **PERSONAL:** Do you have faith in Jesus Christ so you can be right with God? Have you confessed your sins to God? Have you asked Jesus to live in you through His Holy Spirit to help you obey God? If you have done that, what does Romans 10:9,10 promise you?

Read Romans chapter 7, verses 7 - 12.

1. What did the Law teach Paul?

When you were a baby, you were allowed to get away with all kinds of things that you are not allowed to get away with now that you are older. You slept, ate, played, and even dirtied your pants when you wanted to. It wasn't wrong for you to do these things. But as you got older, you had rules to follow. One rule was the bedtime rule. Now you have to go to bed when you are told to, or you have a time you must be in bed. If you don't obey this rule, you are doing something wrong. You didn't know about the bedtime rule when you were a baby, so when you broke it, you did nothing wrong. But now that you know the rule, you are expected to obey it. Oh, but there are lots of times you don't want to obey the bedtime rule. Staying up is more fun. You don't want to miss all that's going on in the house. So now when you break the bedtime rule, you do something wrong, and you are probably punished. That's what Paul is saying about the Law. Before the Law came, man didn't know his actions were sinful. When the Law came, man came to know his actions were sinful. But sin, like staying up past bedtime, looks better to us than obeying, just because we know it's wrong. But instead of looking at what we can't have or do, we need to look at all God has given us and all we can do.

2. In Genesis 2:16, what did God give Adam and Eve?

3. What rule did God give them in Genesis 2:17?

4. What did Satan say through the serpent in Genesis 3:1,4,5?

5. God gave Adam and Eve everything in the Garden, except the fruit of one tree that would cause them to die. When Eve was deceived, and she and Adam ate the fruit, they sinned. But God had a way for sins to be forgiven. What does John 3:16 says is this way?

6. What did Paul say about the Law in Romans 7:12?

Read Romans chapter 7, verses 13 - 20.

1. What does Paul say about himself in Romans 7:15,16?

Look at Commandment 10 in this lesson. This commandment “talks about how you feel inside, your desires, your imagination, your ambitions” (STEDMAN). Paul “knew God’s will, and approved what is excellent, yet did not do it. He knew and approved, and intended to do it, but could not” (BRUCE). Paul is saying, “For I have the desire to do what is good But I cannot carry it out” (WALVOORD).

Some of the inner attitudes that the 10th Commandment is talking about are: being proud; being critical of others; and failure to admit you are wrong or have any faults.

2. Paul knew sin still lived in him. He wanted to be without sin. But that is impossible. When will believers in Jesus Christ be without sin? See Philippians 1:6 for your answer.
3. Paul knew he didn't have to give in to sin. What does Philippians 2:13 say that shows how he resisted giving into sin?
4. **PERSONAL:** When you are asked to do something, how do you respond? Do you moan and groan and complain about how hard you have to work? Then you have given in to sin. What do these verses say is the way you should act?

2 Corinthians 9:7

1 Thessalonians 5:18

Read Romans chapter 7, verses 21 - 28.

1. **HARD:** What does Galatians 5:17 say about the battle between God's will and evil?
2. How did Jesus look at this battle? See Matthew 26:41 for your answer.
3. **PERSONAL:** Look at the 10th Commandment again. James 4:1,2 talks about wanting what others have. What does it say? Have you ever wanted what others had? What did you do about it?
4. **RISKY:** Paul says he can be rescued from his body of death and slavery to sin through Jesus Christ. In which verse is that information found?

ROMANS - WEEK EIGHT

DISCUSSION LESSON SEVEN

15 - 20 minutes free time - games; fellowship

15 - 20 minutes snack and group recreation: BEDLAM

This game requires four teams of equal size. Each team takes one corner of the room or playing field. The play area can be either square or rectangular. On a signal (e.g., whistle) each team attempts to move as quickly as possible to the corner diagonally across from their corner, performing an announced activity as they go. The first team to get all its members into its new corner wins that particular round. The first round can be simply running to the opposite corner, but after that you can use any number of possibilities: walking backward, wheelbarrow racing (one player is the wheelbarrow), piggyback, rolling somersaults, hopping on one foot, skipping, crab walking, etc. There will be literally mass bedlam in the center as all four teams crisscross. Alert your safety guards to referee the confusion in the middle where the lines cross. To make it more difficult, one team member must travel from their starting corner and completely reach the opposite corner before the next player from that team can start across.

15 - 20 minutes discuss LESSON 7

to end of class CRAFT: WIND TWIRLER, from Safari Crafts (Gospel Light Publications)

MATERIALS

clear acrylic spray	black, white tempera paints
thick craft glue	5-foot length black yarn per child
measuring stick	scissors
paint brushes	shallow containers
newspapers	glue gun & glue sticks
20 tongue depressors per child	
5 spring-type clothespins per child	

Cover work area with newspapers. Paint 10 tongue depressors black and 10 white, front and back. Allow to dry. Use thick craft glue, to glue a white tongue depressor on top of a black one forming a narrow X (see figure a on the next page). Alternate black and white, glue two more sticks on top of the

first two. Clip a clothespin to the center of glued sticks to hold them together while glue dries (see figure b).

Alternate black and white sticks into stacks of four until only four sticks remain. Clip each section with clothespin.

Glue three of the remaining sticks together. Glue the middle of the yarn length to the center of the top stick. Glue the last stick on top of the yarn (see figure c).

Bring up the loose ends and knot together. Use the glue gun to glue all five sections of twirler together in a continuous spiral (see figure d).

In an outdoor area spray with clear acrylic spray.

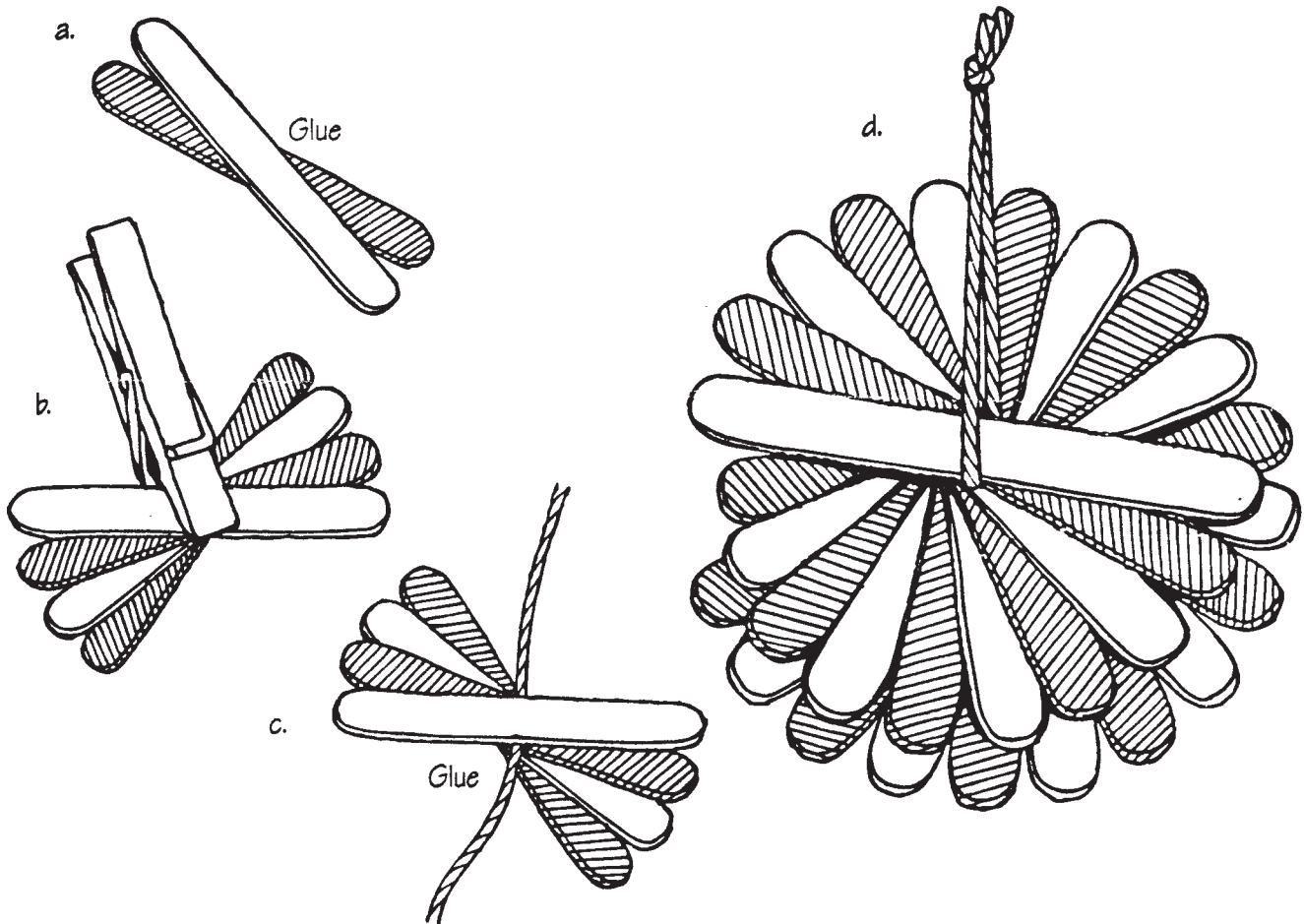

ROMANS LESSON 7 ANSWERS

Read Romans chapter 7, verses 1 - 6.

1. Some of Paul's readers know the law. What do these verses say about the Law?

Romans 5:20 "God's laws were given so that everybody could know how much they had failed. But the more we see our sin, the more we see God's grace forgiving us."

Galatians 3:24 "Let me put it another way. The Jewish laws were our teacher and guide until Christ came. He gave us right standing with God through our faith."

James 2:10 "What if someone keeps every law but makes one little slip? He is just as guilty as the person who has broken every law."

In Exodus 20:2-17 we find the Ten Commandments. These Commandments are the most important part of the Law God gave to Moses. There are other laws in the books of Leviticus and Deuteronomy. For now, we will look at the Ten Commandments. Verse 2 says God freed the Israelites from slavery in Egypt. Just as Paul says, in this chapter and throughout the entire book of Romans, we are freed from the slavery of sin. The Ten Commandments are listed below. Read them so you will remember what they are, and to understand the questions in this lesson.

1. "Do not worship any other god but me."
 2. "You shall not make any idols. Make no images of animals, birds, or fish. You must never bow or worship an idol in any way. For I, the Lord your God, want you to be mine. I will not share your love with any other god!"
 3. You shall not use the name of the Lord your God irreverently. Nor shall you use it to swear. You will not escape punishment if you do."
 4. "Remember to observe the Sabbath as a holy day. Six days a week are for your daily duties and your regular work. But the seventh day is a day of Sabbath rest before the Lord your God."
 5. "Honor your father and mother. Do this that you may have a long, good life in the land the Lord your God will give you."
 6. "You must not murder."
 7. "You must not commit adultery."
 8. "You must not steal."
 9. "You must not lie."
 10. "You must not envy your neighbor's house. You must not want to sleep with his wife. You must not want to own his slaves, oxen, donkeys, or anything else he has."
2. When we break God's law, we sin. We are not right with God. What does Galatians 2:16 say is the way to get right with God? "Yet we know that we can't become right with God by obeying

our Jewish laws. We know that our sins are forgiven only by faith in Jesus Christ. So we have trusted Jesus Christ, too. Now God welcomes us because of faith. He doesn't welcome us because we obey the Jewish laws. For no one will ever be saved by obeying them."

3. **PERSONAL:** Do you have faith in Jesus Christ so you can be right with God? Have you confessed your sins to God? Have you asked Jesus to live in you through His Holy Spirit to help you obey God? If you have done that, what does Romans 10:9,10 promise you? "This is how you will be saved. Tell others with your own mouth that Jesus Christ is your Lord. Also, believe in your own heart that God has raised him from the dead. Because it is by believing in his heart that a man becomes right with God. With his mouth he tells others about his faith and is saved."

Read Romans chapter 7, verses 7 - 12.

1. What did the Law teach Paul? Verse 7: "Am I saying that these laws of God are evil? Of course not! No, the law is not sinful. But it was the law that showed me my sin. I wouldn't have known the sin in my heart. The law told me about it. It said, 'You must not have evil desires in your heart.'" ["Without its clear guidelines for right and wrong, moral behavior would be mostly guess work. Don't you remember how it was? I do, perfectly well. The law code started out as an excellent piece of work. What happened, though, was that sin found a way to pervert the command into a temptation, making a piece of 'forbidden fruit' out of it. The law code, instead of being used to guide me, was used to seduce me. Without all the paraphernalia of the law code, sin looked pretty dull and lifeless, and I went along without paying much attention to it. But once sin got its hands on the law code and decked itself out in all that finery, I was fooled, and fell for it. The very command that was supposed to guide me into life was cleverly used to trip me up, throwing me headlong. So sin was plenty alive, and I was stone dead. But the law code itself is God's good and common sense, each command sane and holy counsel" (THE MESSAGE).]

When you were a baby, you were allowed to get away with all kinds of things that you are not allowed to get away with now that you are older. You slept, ate, played, and even dirtied your pants when you wanted to. It wasn't wrong for you to do these things. But as you got older, you had rules to follow. One rule was the bedtime rule. Now you have to go to bed when you are told to, or you have a time you must be in bed. If you don't obey this rule, you are doing something wrong. You didn't know about the bedtime rule when you were a baby, so when you broke it, you did nothing wrong. But now that you know the rule, you are expected to obey it. Oh, but there are lots of times you don't want to obey the bedtime rule. Staying up is more fun. You don't want to miss all that's going on in the house. So now when you break the bedtime rule, you do something wrong, and you are probably punished. That's what Paul is saying about the Law. Before the Law came, man didn't know his actions were sinful. When the Law came, man came to know his actions were sinful. But sin, like staying up past bedtime, looks better to us than obeying, just because we know it's wrong. But instead of looking at what we can't have or do, we need to look at all God has given us and all we can do.

2. In Genesis 2:16, what did God give Adam and Eve? “And the Lord God commanded the man, ‘You are free to eat from any tree in the garden.’”
3. What rule did God give them in Genesis 2:17? “But you must not eat from the tree of the knowledge of good and evil, for when you eat of it you will surely die.”
4. What did Satan say through the serpent in Genesis 3:1,4,5? “‘The serpent was the craftiest of all the creatures the Lord God had made. So the serpent came to the woman. ‘Really?’ he asked. ‘None of the fruit in the garden? God says you mustn’t eat any of it? That’s a lie!’ the serpent hissed. ‘You’ll not die! God knows very well that as soon as you eat it you will become like him. Your eyes will be opened. You will be able to know good from evil!’”
5. God gave Adam and Eve everything in the Garden, except the fruit of one tree that would cause them to die. When Eve was deceived, and she and Adam ate the fruit, they sinned. But God had a way for sins to be forgiven. What does John 3:16 say is this way? “God loved the world so much that he gave his only Son. Anyone who believes in him will not die but have eternal life.”
6. What did Paul say about the Law in Romans 7:12? “But the law is still right and good.”

Read Romans chapter 7, verses 13 - 20.

1. What does Paul say about himself in Romans 7:15,16? “I don’t understand myself at all. I really want to do what is right, but I can’t. Instead I do what I don’t want to do. I do the things I hate. I know what I am doing is wrong. I know that these laws I am breaking are right and good.”

Look at Commandment 10 in this lesson. This commandment “talks about how you feel inside, your desires, your imagination, your ambitions” (STEDMAN). Paul “knew God’s will, and approved what is excellent, yet did not do it. He knew and approved, and intended to do it, but could not” (BRUCE). Paul is saying, “For I have the desire to do what is good But I cannot carry it out” (WALVOORD).

Some of the inner attitudes that the 10th Commandment is talking about are: being proud; being critical of others; and failure to admit you are wrong or have any faults.

2. You might think you do good things because Jesus lives in your heart. But that doesn’t mean you don’t sin. What does Isaiah 64:6 say about all the good things you do? “We are all infected and impure with sin. We put on our robes of righteousness, but we find they are dirty rags. Like the leaves in fall, we fade, dry up, and fall down. And our sins, like the wind, blow us away.”
3. Paul knew sin still lived in him. He wanted to be without sin. But that is impossible. When will believers in Jesus Christ be without sin? See Philippians 1:6 for your answer. “God began the good work within you. I am sure he will finish it until Jesus Christ comes back.”

4. Paul knew he didn't have to give in to sin. What does Philippians 2:13 say that shows how he resisted giving into sin? "For God is at work within you. He helps you want to obey him. And he helps you do what he wants."
5. **PERSONAL:** When you are asked to do something, how do you respond? Do you moan and groan and complain about how hard you have to work? Then you have given in to sin. What do these verses say is the way you should act?

2 Corinthians 9:7 "Each person should decide how much he should give. No one should force him to give. God loves cheerful givers." [This verse speaks about giving of one's means, but the point being made is "to be cheerful in everything you do."]

1 Thessalonians 5:18 "No matter what happens, always be thankful. This is God's will for you who belong to Christ Jesus."

Read Romans chapter 7, verses 21 - 28.

1. **HARD:** What does Galatians 5:17 say about the battle between God's will and evil? "For we love to do evil things. And these things are against the things the Holy Spirit tells us to do. But we do good things when the Spirit has his way with us. They are against our natural desires. These two forces in us are always fighting to win control over us. Our wishes are never free from their demands."
2. How did Jesus look at this battle? See Matthew 26:41 for your answer. "Stay awake and pray. If you don't you won't be able to stand when you are tempted. For your spirit wants to do what is right. But your body is very weak!"
3. **PERSONAL:** Look at the 10th Commandment again. James 4:1,2 talks about wanting what others have. What does it say? Have you ever wanted what others had? What did you do about it? James 4:1,2: "What is causing the fights among you? Isn't it because there is a whole army of evil desires within you? You want what you don't have. So you kill to get it! You long for what others have. So you start a fight to take it away! Why don't you have what you want? Because you don't ask God for it."
4. **RISKY:** Paul says he can be rescued from his body of death and slavery to sin through Jesus Christ. In which verse is that information found? Verse 25a: "Thank God! It has been done by Jesus Christ our Lord. He has set me free!"

ROMANS - LESSON 8

Before you begin your lesson:

- Pray for God's Holy Spirit to help you answer the questions.
- Some questions may be too hard; it's ok to write "I don't know."
- Think about what God's Word is telling you for today.
- With some questions, it might be helpful to write the scripture verses on your paper.

Read Romans chapter 8, verses 1 - 4.

To condemn means "to express strong disapproval of" [someone or something], "To declare guilty in court" (HOLT).

- What did the law of the Spirit of life through Jesus Christ do for Paul and all Christians?
- What was Jesus God's Son, sent to do?
- What did the angel tell Joseph in Matthew 1:21?
- What does Jesus say about Himself in Matthew 5:17,18?

Read Romans chapter 8, verses 5 - 11.

- Galatians 5:19-22 lists what the sinful nature does, and what the Spirit led nature does. Put them in the correct columns below.

SINFUL NATURE		SPIRIT LED NATURE

2. What does Hebrews 11:6 tell you to do?

3. **PERSONAL:** The Lord wants you to be led by His Spirit. But you cannot have your mind set on the Spirit's desires unless the Holy Spirit helps you. Have you asked Jesus into your life as Lord and Savior? Then the Holy Spirit will help you live the way God wants you to live. If you haven't done that yet, why not do it now? Confess your sins, believe that Jesus died for you and that He is God's Son. Ask Him to make His home in you. And then the Holy Spirit will come and help you to live to please God.

4. What do these verses say is the place where God's Holy Spirit lives?

Galatians 4:6

Ephesians 3:17

5. What does your mortal body get if the Holy Spirit lives in you?

Read Romans chapter 8, verses 12 - 27.

1. Who are called the sons of God?

2. What does John 1:12 say you must do to become God's son?

3. **RISKY:** Verse 17 says: "Since we are his children, we will share his treasures. All God gives to his Son Jesus is ours too. But if we share his glory, we have to share his suffering too." What are some of God's treasures, and how do we suffer as Christians?

4. What does 2 Corinthians 4:17 say about the trouble and the blessing Christians have?

5. People who live to please God and to share the gospel will have troubles; they will suffer for their faith. What does 1 Peter 5:9 tell you about Christians today?

6. **HARD:** Besides humans, is there anything else that is suffering because Adam sinned? Give the verse or verses for your answer.

7. What does the Spirit do for us?

Read Romans chapter 8, verses 28 - 39.

1. Why does God work good in everything that happens to us?

2. What separates us, or keeps us away from, God's love? Give verse or verses with your answer.

3. What does 1 John 2:1,2 tell you Jesus does for you?

4. **PERSONAL:** Which verse did you choose to memorize this week? Can you say it to your class?

ROMANS - WEEK NINE

DISCUSSION LESSON EIGHT

15 - 20 minutes free time - games; fellowship

15 - 20 minutes snack and group recreation: MY FATHER DOESN'T LIKE

This is a trick game. The object is name another type of food with the tea, but the object is not told to the players. Either chose a leader from the players, or the teacher can begin the play. Number players, and then sit in a circle. The leader begins by saying "My father doesn't like tea, but he does like orange juice." (The trick is to use a food that doesn't have a "T" in it.) The next person says "My father doesn't like tea, but he does like _____" (and he says something else to eat). If the second player doesn't name a food, the leader says "No, my father doesn't like" (and then names what the previous player named), "but, he does like green beans" (or something else to eat or drink that doesn't have a "T" in it).

This is repeated, even returning to the leader and repeating the statement, until all players catch on or give up. The leader can change when someone thinks he knows the trick, and upon proving it, becomes the leader. If his guess is incorrect, the previous leader remains leader.

15 - 20 minutes discuss LESSON 8

to end of class CRAFT: CHRISTMAS WREATH

MATERIALS

2 large paper plates per child

bow (paper or fabric)

brushes

nativity stickers (see following pages)

glue

green tempera paint

Cut the center circle out of two paper plates and glue together to form the wreath. Paint the wreath green. Glue each sticker sheet onto construction paper, color, cut out, and glue to the paper plate wreath. (Gluing the sheet onto construction paper makes the stickers stronger.) Attach bow to wreath.

Sticker Pattern

Glue each sticker sheet onto construction paper, color, cut out, and glue to the paper plate wreath. (Gluing the sheet onto construction paper makes the stickers stronger.)



Wisemen

Joseph

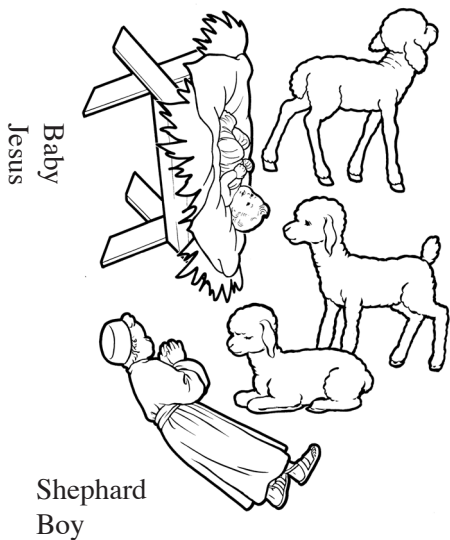

Baby
Jesus

Shepherd
Boy



Mary

Shepherds

If you have time, you may wish to use this fun game.

HOLIDAY TUNES IN DISGUISE

1. Colorless Yuletide
2. Castaneous-Colored Seed Vesicated in a Conflagration
3. Singular Yearning for the Twin Anterior Incisors
4. Righteous Darkness
5. Arrival Time: 2400 hrs; Weather: Cloudless
6. Loyal Followers Advance
7. Far Off in a Feeder
8. Array the Corridors
9. Bantam Male Percussionist
10. Monarchical Triad
11. Nocturnal Noiselessness
12. Jehovah Deactivate Blithe Chevaliers
13. Red Man en Route to Borough
14. Frozen Precipitation Commence
15. Proceed and Enlighten on the Pinnacle
16. The Quadruped with the Vermilion Proboscis
17. Query Regarding Identity of Descendent
18. Delight for this Planet
19. Give Attention to the Melodious Celestial Beings
20. The Dozen Festive 24 Hour Intervals

ANSWERS

1. White Christmas
2. Chestnuts Roasting On An Open Fire
3. All I Want For Christmas Is My Two Front Teeth
4. O Holy Night
5. It Came Upon A Midnight Clear
6. Oh Come All Ye Faithful
7. Away In A Manger
8. Deck The Halls
9. Little Drummer Boy
10. We Three Kings
11. Silent Night
12. God Rest Ye Merry Gentlemen
13. Santa Claus Is Coming To Town
14. Let It Snow
15. Go Tell It On The Mountain
16. Rudolph The Red-nosed Raindeer
17. What Child Is This?
18. Joy To The World
19. Hark The Herald Angels Sing
20. Twelve Days of Christmas

ROMANS

LESSON 8 ANSWERS

Read Romans chapter 8, verses 1 - 4.

To condemn means “to express strong disapproval of” [someone or something], “To declare guilty in court” (HOLT).

1. What did the law of the Spirit of life through Jesus Christ do for Paul and all Christians? Verse 2: “Because the life-giving Spirit has set me free from sin and death.”
2. What was Jesus, God’s Son, sent to do? Verse 3: “We aren’t saved from sin because we know God’s laws. We can’t keep them. But God had a different plan to save us. He sent his own Son. Jesus Christ had a body like ours, except he didn’t use his for sin. Instead he destroyed sin by dying on the cross for our sins.”
3. What did the angel tell Joseph in Matthew 1:21? “She will have a Son, and you shall name him Jesus. This means ‘Savior,’ for he will save his people from their sins”
4. What does Jesus say about Himself in Matthew 5:17,18? “Don’t think I’ve come to cancel the laws of Moses and the words of the prophets. No, I came to fulfill them. I came to make them all come true. I tell you the truth! Every law in the Book will continue until its purpose is achieved.” [Christ’s death on the cross, fulfilled the sin offering part of the Law.]

Read Romans chapter 8, verses 5 - 11.

1. Galatians 5:19-22 lists what the sinful nature does, and what the Spirit led nature does. Put them in the correct columns below.

SINFUL NATURE		SPIRIT LED NATURE
<u>impure thought</u> <u>lustful pleasures</u> <u>idolatry</u> <u>spiritism</u> <u>hatred</u> <u>fighting</u> <u>jealousy</u> <u>anger</u> <u>arguments</u> <u>criticism</u>	<u>everyone else is wrong</u> <u>but me and my group</u> <u>wrong doctrine</u> <u>envy</u> <u>murder</u> <u>drunkenness</u> <u>wild parties</u>	<u>love</u> <u>joy</u> <u>peace</u> <u>patience</u> <u>kindness</u> <u>goodness</u> <u>faith</u> <u>gentleness</u> <u>self-control</u>

2. What does Hebrews 11:6 tell you to do? “You can never please God without faith. You cannot please him without depending on him. Anyone who wants to come to God must believe that there is a God. They also must believe that he rewards those who truly look for him.”

3. **PERSONAL:** The Lord wants you to be led by His Spirit. But you cannot have your mind set on the Spirit's desires unless the Holy Spirit helps you. Have you asked Jesus into your life as Lord and Savior? Then the Holy Spirit will help you live the way God wants you to live. If you haven't done that yet, why not do it now? Confess your sins, believe that Jesus died for you and that He is God's Son. Ask Him to make His home in you. And then the Holy Spirit will come and help you to live to please God.
4. What do these verses say is the place where God's Holy Spirit lives?

Galatians 4:6 "We are God's sons. So God has sent the Spirit of his Son into our hearts. Now we can say that God is our dear Father."

Ephesians 3:17 "I pray that Christ will be more and more at home in your hearts. He will live within you as you trust in him. May your roots go down deep into the soil of God's love."

5. What does your mortal body get if the Holy Spirit lives in you? Verse 11: "The Spirit of God raised up Jesus from the dead. This Spirit lives in you. He will make your bodies live again after you die. How? Because this same Holy Spirit lives in you."

Read Romans chapter 8, verses 12 - 27.

1. Who are called the sons of God? Verse 14: "Because everybody who is led by God's Spirit is a son of God."
2. What does John 1:12 say you must do to become God's son? "But to all who received him, he gave the right to become God's children. All they needed to do was to believe in him."
3. **RISKY:** Verse 17 says: "Since we are his children, we will share his treasures. All God gives to his Son Jesus is ours too. But if we share his glory, we have to share his suffering too." What are some of God's treasures and how do we suffer if we are Christians? [Allow the children to express themselves, and ask questions. This can open a rewarding time of sharing.]
4. What does 2 Corinthians 4:17 say about the trouble and the blessing Christians have? "These troubles are quite small and won't last very long. This short time of trouble will bring God's richest blessing upon us forever." [Of course, the final blessing is heaven, eternity with God. "So, our sufferings as believers—physical, emotional, whatever they may be—are directly linked with the glory that is coming. The important thing we need to see is that both the sufferings and the glory are privileges given to us" (STEDMAN). But we don't suffer to be heirs. "That would imply that Christ's suffering on the cross was not enough for our salvation. But the fact is we will suffer as heirs. We can expect suffering in at least two ways: (1) By identifying with

Christ in his suffering (Phil. 3:10, 2 Cor. 1:5). If he agonized over the world to reach it, we will face similar struggles. (2) By facing persecution for our faith (Matt. 5:10-12; 2 Tim. 3:12). If the world is hostile to the Lord, we shouldn't be surprised if it is hostile to those who follow him" (QUEST).

5. People who live to please God and to share the gospel will have troubles; they will suffer for their faith. What does 1 Peter 5:9 tell you about Christians today? "Stand firm when he attacks. Trust the Lord. Remember that other Christians all around the world are going through these sufferings too."
6. **HARD:** Besides humans, is there anything else that is suffering because Adam sinned? Give the verse or verses for your answer. Yes, verses 19, 22: "All creation is waiting patiently for the day when God will resurrect his children... We know that the animals and plants suffer as they wait for this great event."
7. What does the Spirit do for us? Verse 26,27: "And in the same way the Holy Spirit helps us with our prayers. We don't know what we should pray. So the Holy Spirit prays for us. He has feelings that can't be spoken with words. God knows all our hearts. He also knows what the Spirit is praying. Because the Spirit prays the way God wants."

Read Romans chapter 8, verses 28 - 39.

1. Why does God work good in everything that happens to us? Verse 29: "From the very beginning God knew who would come to him. He decided that they would become like his son. That way his Son would be the First, with many brothers."
2. What separates us, or keeps us away from, God's love? Give verse or verses with your answer. Nothing. Verses 38,39: "I am sure that nothing can ever separate us from his love. All the powers of hell can't keep God's love away. Our fears for today, and our worries about tomorrow can't either. It doesn't matter if we are high above the sky, or deep in the ocean. Nothing can carry us away from God's love that is in our Lord Jesus Christ."
3. What does 1 John 2:1,2 tell you Jesus does for you? "My little children, I'm telling you this so you will stay away from sin. But if you sin, there is someone to beg for you before the Father. His name is Jesus Christ. He is all that is good, and he pleases God completely. He took God's anger against our sins upon himself. He brought us into fellowship with God. He is the forgiveness for our sins. And he brings forgiveness to all the sins of the world."
4. **PERSONAL:** Which verse did you choose to memorize this week? Can you say it to your class?

ROMANS - LESSON 9

Before you begin your lesson:

- a. Pray for God's Holy Spirit to help you answer the questions.
- b. Some questions may be too hard; it's ok to write "I don't know."
- c. Think about what God's Word is telling you for today.
- d. With some questions, it might be helpful to write the scripture verses on your paper.

Read Romans chapter 9, verses 1 - 18.

1. For whom does Paul feel sorry?

2. Today, when Israel is talked about, you think of a country. But in the Bible a man is called Israel. And from him came the people of Israel. From Genesis 32:27,28, what is this man's name?

3. Who is the most famous person ever to come from Israel? See Romans 9 for your answer.

4. Matthew 1:1-17 lists Christ's ancestors. Abraham is listed as the father of Isaac, the child who was the fulfillment of God's promise. But Abraham had a son before Isaac was born. You will find his name in Genesis 16:11. Who is it?

5. Read Genesis 25:22-26. Isaac's first born son would be a servant to the second son. Which son was born first?

6. **HARD:** Will you get a right standing with God if you do good deeds? See Romans 9 for your answer.

7. **RISKY:** Who can have a right standing with God? See John 3:16,17 for your answer.

8. How can you get a right standing with God? See John 1:12.

9. **PERSONAL:** Have you received Jesus into your heart? Is God calling you? Do you feel His Holy Spirit speaking to your heart? Why not confess your sins and ask Jesus to be your Savior? Ask Him into your heart to help you live to please Him.

Read Romans chapter 9, verses 19 - 33.

1. **HARD:** What does Paul ask in Romans 9:20?

When you played with modeling clay, did you make many objects? Because you were the one making the objects, you had the right to make whatever you wanted. You were boss over the clay. Well, since God is the Creator, He is the boss over all He created, including man. And God has the right to shape people any way He wants.

2. What does the potter have the right to do?

3. How did the Gentiles get righteousness?

4. **CHALLENGE:** How did Israel choose to get righteousness?

Read Romans chapter 10, verses 1 - 21.

1. What does Paul want for the Israelites?
2. The Israelites had God's written word when He gave them His Commandments through Moses hundreds of years before Paul wrote this letter. They also had His word as a person. Who is this person in John 1:1?
3. What do these verses say about being saved?

Acts 4:12

Romans 10:9,10

4. **RISKY:** John 3:16 says, "God loved the world so much that he gave his only Son. Anyone who believes in him will not die but have eternal life." Jesus came to save the whole world. In Romans 10:21 Paul is writing about God's love for the Jews. But God says the same about all people today. What does this verse say is the reason people don't accept God's gift of salvation?

Read Romans chapter 11, verses 1 - 36.

1. Is Paul a Gentile or an Israelite? Give the verse with your answer.
2. What have the Gentiles received because Israel rejected Christ?
3. How long should God receive praise and glory?

ROMANS - WEEK TEN

DISCUSSION LESSON NINE

15 - 20 minutes free time - games; fellowship

15 - 20 minutes snack and group recreation: ANATOMY SHUFFLE

Divide into groups of two, to make two concentric circles – one member of each pair in the inner circle, and the other in the outer circle.

The outer circle begins traveling clockwise, while the inner circle goes counterclockwise. When the leader blows a whistle (or yells, “Anatomy shuffle”), and calls out, “hand-ear”, the outer circle stops and the inner circle must find their partners and place their hands on their partner’s ears. The last pair to do so is out. The first body part called is what the inner circle players must touch to the proper body part of their partners. The second body part called is what the kids in the outer circle touch with their partners from the inner circle. The leader calls out all sorts of combinations such as:

finger-foot	nose-shoulder
wrist-knee	thigh-thigh
head-stomach	foot-head
elbow-nose	nose-nose
back-back	

15 - 20 minutes discuss LESSON 9

to end of class CRAFT: TRINKET or FAVOR BASKET; pattern from Safari Crafts

MATERIALS

colored poster board	construction paper
pencil	felt pens
ruler	scissors
glue	spring-type clothespins
raffia or thick craft yarn or rug yarn	

Trace the basket pattern (see following pages) onto the poster board and have each child cut it out. Score along the dotted lines with the scissors’ point. Bend flaps up to make sides of basket (see figure a). Cut several 3-foot lengths of raffia, or yarn, per child. Cut five 1”x 3” strips of construction paper per child.

Glue one end of raffia or yarn on the inside left edge of a basket flap, and bring it across the inside to the right side of same flap, then wrap around the outside the next flap (see figure b). Continue weaving around flaps until weaving is 1/2" from top of basket. Cut raffia or yarn and fasten end with glue. Fold the 3" strips of construction paper in half and finish the top of the basket by gluing each piece across the sections of the basket (see figure c). Use the clothespins to hold the paper in place as glue dries. Use the basket for nuts or mints, as favors, to hold special items, or to put offering in for Sunday worship.

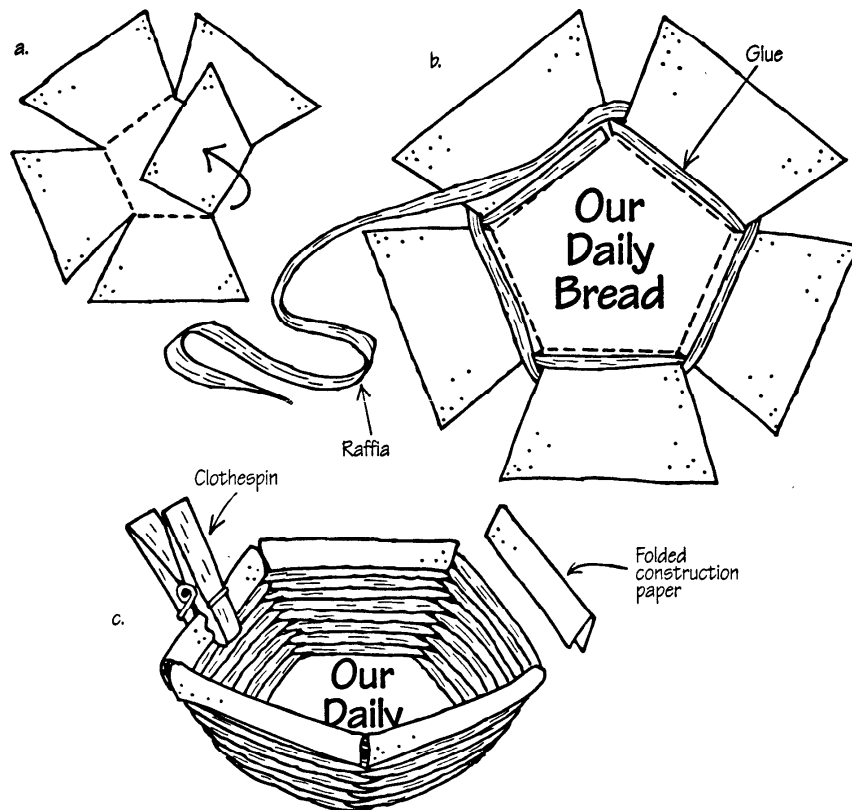

Pattern for “Favor Basket”

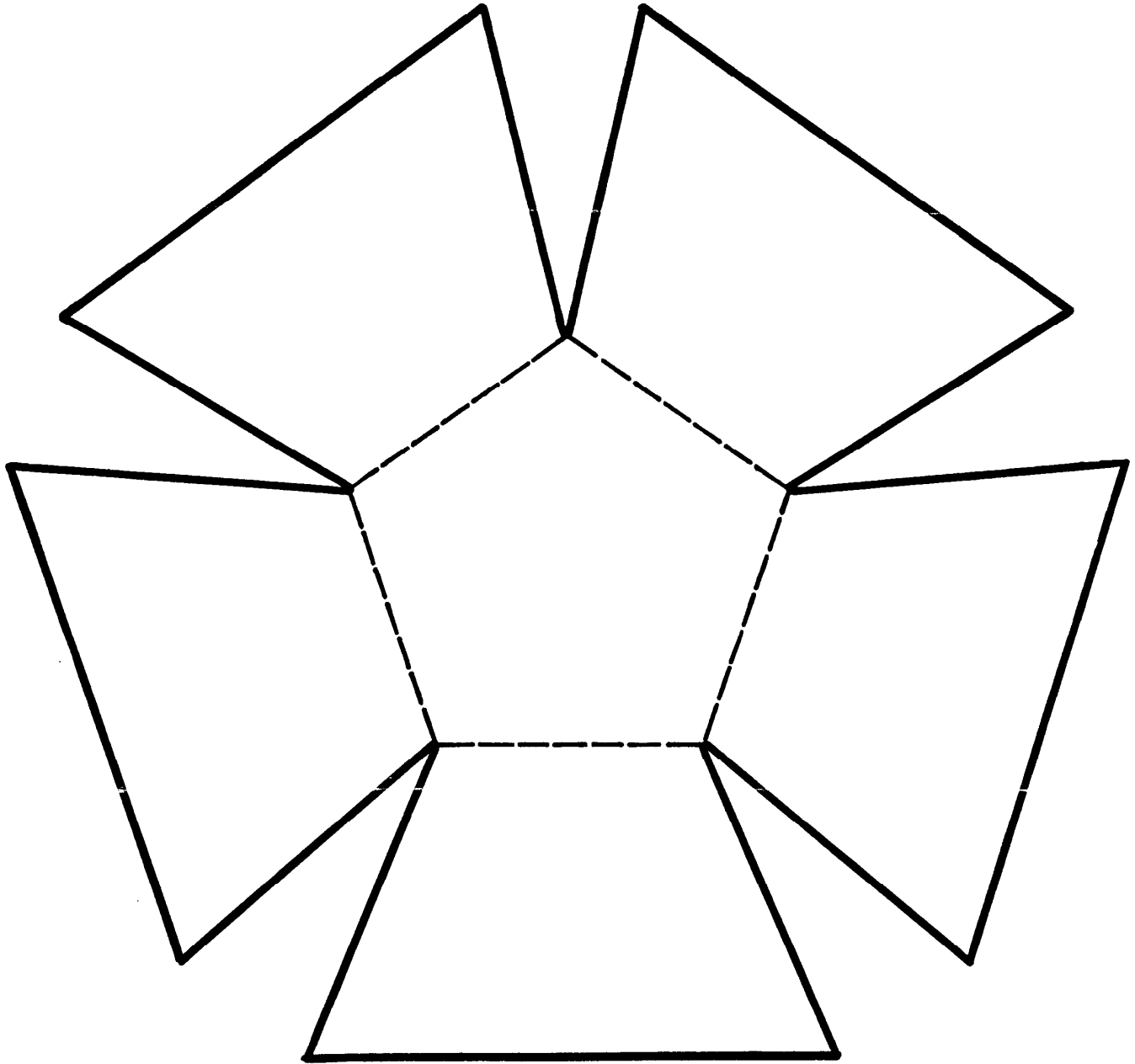

ROMANS

LESSON 9 ANSWERS

Read Romans chapter 9, verses 1 - 18.

1. For whom does Paul feel sorry? Verse 3,4a: “For I wish that I myself were cursed and cut off from Christ for the sake of my brothers, those of my own race, the people of Israel” (NIV). [The Jews of that day thought the gospel was false, or that God did not keep His promises to Israel. Paul felt sorry for them because many rejected salvation through Christ.]
2. Today when Israel is talked about, you think of a country. But in the Bible a man is called Israel. And from him came the people of Israel. From Genesis 32:27,28, what is this man’s name? Jacob. ““What is your name?” the Man asked. ‘Jacob,’ was the reply. ‘It isn’t anymore!’ the Man told him. ‘It is Israel—one who has power with God. Because you have been strong with God, you shall prevail with men.’”
3. Who is the most famous person ever to come from Israel? See Romans 9 for your answer. Verse 5: “Great men of God were your fathers. Christ himself was one of you. He was a Jew in his human nature. He now rules over all things. Praise God forever!”
4. Matthew 1:1-17 lists Christ’s ancestors. Abraham is listed as the father of Isaac, the child who was the fulfillment of God’s promise. But Abraham had a son before Isaac was born. You will find his name in Genesis 16:11. Who is it? “Yes, you are pregnant and your baby will be a son. You are to name him Ishmael (‘God hears’), because God has heard your woes.” [Although Abraham had many blood descendants, they were not descendants of the promise. Isaac was the promised son and his descendants are the ones who become the Israelites, and became the physical line for the Messiah.]
5. Read Genesis 25:22-26. Isaac’s first born son would be a servant to the second son. Which son was born first? Verse 25: “The first was born so covered with reddish hair that one would think he was wearing a fur coat! So they called him “Esau”.
6. **HARD:** Will you get a right standing with God if you do good deeds? See Romans 9 for your answer. No, verse 12: “And God said this before the children were even born. He said it before they had done anything either good or bad. This proves that God was doing what he had decided from the beginning. It was not because of what the children did. It was because of what God wanted and chose.” [God chose Jacob before the twins were born, before they could do anything right or wrong. It was His decision, which He has the right to make.]
7. **RISKY:** Who can have a right standing with God? See John 3:16,17 for your answer. “God loved the world so much that he gave his only Son. Anyone who believes in him will not die but have eternal life. God did not send his Son into the world to judge it. He sent his Son to save it.”

8. How can you get a right standing with God? See John 1:12. “Only a few would welcome and receive him. But to all who received him, he gave the right to become God’s children. All they needed to do was to believe in him.”
9. **PERSONAL:** Have you received Jesus into your heart? Is God calling you? Do you feel His Holy Spirit speaking to your heart? Why not confess your sins and ask Jesus to be your Savior? Ask Him into you heart to help you live to please Him.

Read Romans chapter 9, verses 19 - 33.

1. **HARD:** What does Paul ask in Romans 9:20? “No, don’t say that. Who are you to question God? Should the thing that is made question the one who made it? Should it say, ‘Why have you made me like this?’”

When you played with modeling clay, did you make many objects? Because you were the one making the objects, you had the right to make whatever you wanted. You were boss over the clay. Well, since God is the Creator, He is the boss over all He created, including man. And God has the right to shape people any way He wants.

2. What does the potter have the right to do? Verse 21: “A man can use some clay to make a beautiful jar for flowers. He can use the same clay and make a jar for garbage.”
3. How did the Gentiles get righteousness? Verse 30: “Well then, what shall we say about these things? Just this, that God has given the Gentiles a chance. They can be saved by faith, even though they had not been seeking God.”
4. **CHALLENGE:** How did Israel choose to get righteousness? Verses 31,32: “But the Jews tried so hard to get right with God by keeping his laws. But they never succeeded. Why not? Because they wanted to be saved by keeping the law instead of by faith. They have tripped over the great stumbling stone.”

Read Romans chapter 10, verses 1 - 21.

1. What does Paul want for the Israelites? Verse 1: “Dear brothers, I hope and pray that the Jewish people will be saved.”
2. The Israelites had God’s written word when He gave them His Commandments through Moses hundreds of years before Paul wrote this letter. They also had His word as a person. Who is this person in John 1:1? “Before anything else existed, there was God’s Son. He was the Word, and he was with God.”

3. What do these verses say about being saved?
Acts 4:12 “There is salvation in no one else! Under all Heaven there is no other name for men to call upon to save them.”

Romans 10:9,10 “This is how you will be saved. Tell others with your own mouth that Jesus Christ is your Lord. Also, believe in your own heart that God has raised him from the dead. Because it is by believing in his heart that a man becomes right with God. With his mouth he tells others about his faith and is saved.” [Salvation has three definitions. Salvation from sin’s penalty is justification. Salvation from sin’s power is sanctification. And salvation from sin’s presence is glorification.]

4. **RISKY:** John 3:16 says, “God loved the world so much that he gave his only Son. Anyone who believes in him will not die but have eternal life.” Jesus came to save the whole world. In Romans 10:21 Paul is writing about God’s love for the Jews. But God says the same about all people today. What does this verse say is the reason people don’t accept God’s gift of salvation? “All day long I have held out my hands to a disobedient and obstinate people.” [It is each person’s responsibility to accept God’s gift of salvation.]

Read Romans chapter 11, verses 1 - 36.

1. Is Paul a Gentile or an Israelite? Give the verse with your answer. Israelite, verse 1: “I ask then, has God rejected and left his people the Jews? Oh no, not at all! Remember that I myself am a Jew. I am a child of Abraham and a member of Benjamin’s family.”
2. What have the Gentiles received because Israel rejected Christ? Salvation, verse 11b. “Again I ask: “Did they stumble so as to fall beyond recovery? Not at all! Rather, because of their transgression, salvation has come to the Gentiles to make Israel envious” (NIV).
3. How long should God receive praise and glory? Verse 36: “For everything comes from God alone. Everything lives by his power. Everything is for his glory. To him be glory evermore!”

4. What do these verses say about the world's wisdom?

Isaiah 44:25

1 Corinthians 1:20

5. With our minds we think. What does Philippians 4:8 say we are to think about?

6. Read 1 Thessalonians 5:16-18. List three things that are God's will for Christians in Christ Jesus.

Read Romans chapter 12, verses 3 - 8.

1. How are Christians supposed to think of themselves?

2. Thinking yourself better than others is prideful. What do these verses say about pride?

Proverbs 11:2

Proverbs 13:10

3. God has given Christians gifts. He is pleased when they use their gifts to serve Him and others. What does Philippians 2:3,4 say is the way we should use our gifts to serve others?

Below is a list of God's gifts and the scriptures where they are found.

Romans 12:6-8 - prophesy, serve others, teach, preach, be generous in giving, show leadership, comfort

1 Corinthians 12:8-10 - give wise advice, teach, show added faith, power to heal, power to do miracles, prophesy, preach, speak languages one hasn't learned, power to understand different languages one didn't learn

4. How and why are Christians to use these gifts? See the following verses.

1 Corinthians 12:11, 25b-26

Ephesians 4:12,13

1 Peter 4:10

5. **CHALLENGE:** Our bodies need food to help us grow. See Ephesians 4:15,16 to find out how the body of Christ grows.

Read Romans chapter 12, verses 9 - 16.

1. What does verse 9 say about love?

2. What does Philippians 2:3,4 say that helps you to honor others?

3. Romans 12:12-16 tells us the way we are to live. Fill in the blanks with the following words:

associate conceited harmony joyful low mourn patient persecute position practice prayer
rejoice share

Be _____ in hope.

_____ in affliction.

Faithful in _____.

_____ hospitality.

Bless those who _____ you.

Rejoice with those who _____.

_____ with those who mourn.

Live in _____ with one another.

Do not be proud, but be willing to _____ with people of

_____.

Do not be _____.

4. **CHALLENGE:** How is a Christian supposed to live with everyone?

5. How is a Christian to treat his enemy?

6. How do you beat evil?

7. **PERSONAL:** Do you need God's help to live the way He wants you to according to the scriptures found in this lesson? Why not ask His help now? Philippians 4:13 says, "I can do everything God asks me to with the help of Christ. He gives me strength and power."

ROMANS - WEEK ELEVEN

DISCUSSION LESSON TEN

15 - 20 minutes free time - games; fellowship

15 - 20 minutes snack and group recreation: **SILLY HAND RELAY**

Divide into two teams, and line up in two rows behind start line. On the finish line, opposite start line, place two containers (shoe boxes, coffee cans, baskets, etc.) for each team. In one container for each team place a pair of large gloves, such as work or garden gloves, and six small objects.

First player on each team, at the start, runs to the container with the gloves and small objects. He puts on the gloves and transfers the objects, one at a time, to the empty container. When that is finished, he removes his gloves and puts them into the now full container. He runs to the second player in line, tags him, and then goes to end of line and sits down. Play continues until all players of one team are sitting in their starting positions. The team finishing first is the winner.

15 - 20 minutes discuss **LESSON 10**

to end of class **CRAFT: DECORATED PENCIL HOLDER**

MATERIALS

clean, empty soup cans with no sharp edges
crayons/colored pencils
tempera paint/brushes
white paper cut to fit around cans like a label
glue

Draw and color or paint a picture depicting a scene from this lesson on the white paper. Glue around outside of can.

ROMANS LESSON 10 ANSWERS

Read Romans chapter 12, verses 1 -2.

1. In Romans 6:13 Paul reminds Christians not to use their bodies as tools of wickedness. What did Paul tell Christians to do with their bodies in Romans 12:1? “And so, dear brothers, I beg with you to give your bodies to God. Let them be a holy, living sacrifice, the kind he can accept. When you think of what he has done for you, is this too much to ask?”
2. What does Paul say about the Christian’s body in 1 Corinthians 6:19,20? “Don’t you know that your body is the home of the Holy spirit? The Holy Spirit lives within you! Your own body does not belong to you. God has bought you with a great price. So use your body to give glory back to God because he owns it!”
3. In Romans 12:1 Paul says when we present our bodies to God it is a holy, living sacrifice. What does Hebrews 13:15 say is one way a Christian can do what Paul suggests? “With Jesus’ help we will always offer our sacrifice of praise to God. We will do this by telling others of the glory of his name.”

From the dictionary this is the meaning of the following words:

conform “To be in agreement with a set pattern or form. To act in accordance with rules, customs, etc.; obey” (HOLT).

renew “To make new again; revive. To take up again. To continue under a new agreement” (HOLT).

transform “To change the nature or appearance of; change into something else. To change the character or personality of” (HOLT).

4. What do these verses say about the world’s wisdom?

Isaiah 44:25 “I am the one who shows what liars all false prophets are. I cause something else to happen than the things they say. I make wise men give opposite advice to what they should. I do this to show they are fools.”

1 Corinthians 1:20 “So what about these wise men? What about these scholars? What about these men who argue about this world’s great affairs? God has made them all look foolish. He has shown their wisdom to be useless nonsense.”

5. With our minds we think. What does Philippians 4:8 say we are to think about? “And now, brothers, as I close this letter, let me say one more thing. Fix your thoughts on what is true and good and right. Think about things that are pure and lovely. Dwell on the fine, good things in others. Think about all you can praise God for and be glad about.”

6. Read 1 Thessalonians 5:16-18. List three things that are God's will for Christians in Christ Jesus. "Always be joyful. Always keep on praying. No matter what happens, always be thankful. This is God's will for you who belong to Christ Jesus."

Read Romans chapter 12, verses 3 - 8.

1. How are Christians supposed to think of themselves? Verse 3: "I am God's messenger. So I want to give each of you God's warning. Be honest when you think about yourself. Measure your value by how much faith God has given you."
2. Thinking yourself better than others is prideful. What do these verses say about pride?

Proverbs 11:2 "Proud people end in shame. But the humble become wise."

Proverbs 13:10 "Pride leads to arguments. Be humble, take advice, and become wise."

3. God has given Christians gifts. He is pleased when they use their gifts to serve Him and others. What does Philippians 2:3,4 say is the way we should use our gifts to serve others? "Don't be selfish. Don't live to impress others. Be humble. Think of others as better than yourself. Don't just think about your own affairs. Be interested in others and in what they are doing." [This doesn't mean inferior. We are to be moderate, sober in some translations, in our thinking about ourselves. Not too highly to be conceited, and not so lowly as to feel inferior. That is not God's intent or what Paul is saying. We are loved by God, and that is an honorable place to be.]

Below is a list of God's gifts and the scriptures where they are found.

Romans 12:6-8 prophesy, serve others, teach, preach, be generous in giving, show leadership, comfort.

1 Corinthians 12:8-10 give wise advice, teach, show added faith, power to heal, power to do miracles, prophesy, preach, speak languages one hasn't learned, power to understand different languages one didn't learn.

4. How and why are Christians to use these gifts? See the following verses.

1 Corinthians 12:11, 25b-26 "It is the same Spirit who gives all these gifts and powers. The Spirit decides which each one of us should have. All the parts have the same care for each other that they do for themselves. If one part suffers, all parts suffer with it. If one part is honored, all the parts are glad."

Ephesians 4:12,13 "Why does he make us able to do certain things best? It is so that God's people will be ready to do better work for him. They will build up the Church, the body of Christ. It will be strong and grown up. Finally we all will have the same beliefs. We will all become full-grown in the Lord. We will come to the point of being filled full with Christ."

1 Peter 4:10 “God has given each of you special abilities. Be sure to use them to help each other. Pass on to others God’s many kinds of blessings.”

5. **CHALLENGE:** Our bodies need food to help us grow. See Ephesians 4:15,16 to find out how the body of Christ grows. “Instead, we will lovingly follow the truth at all times. We will speak truly, deal truly, and live truly. So we will become more in every way like Christ. He is the Head of his body, the Church. Under his direction, the whole body is put together perfectly. Each part helps the other parts in its own special way. Then the whole body is healthy and growing and full of love.”

Read Romans chapter 12, verses 9 - 16.

1. What does verse 9 say about love? “Don’t just pretend that you love others, really love them! Hate what is wrong. Stand on the side of the good.”
2. What does Philippians 2:3,4 say that helps you to honor others? “Don’t be selfish. Don’t live to impress others. Be humble. Think of others as better than yourself. Don’t just think about your own affairs. Be interested in others and in what they are doing.”

3. Romans 12:12-16 tells us the way we are to live. Fill in the blanks with the following words:
joyful patient prayer share practice persecute rejoice mourn harmony associate low position conceited

Be joyful in hope.

Patient in affliction.

Faithful in prayer.

Practice hospitality.

Bless those who persecute you.

Mourn with those who mourn.

Live in harmony with one another.

Do not be proud, but be willing to associate with people of low position.

Rejoice with those who rejoice.

Do not be conceited.

4. **CHALLENGE:** How is a Christian supposed to live with everyone? Verse 18: “Don’t argue with anyone. Be at peace with everyone as much as you can.” [In other words, don’t pick or start fights with someone else.]
5. How is a Christian to treat his enemy? Verse 20: “Instead, feed your enemy if he is hungry. If he is thirsty give him something to drink. If you do this you will be ‘heaping coals of fire on his head.’” That means he will feel bad about what he has done to you.”
6. How do you beat evil? Verse 21: “Don’t let evil be the winner. Crush evil by doing good.”
7. **PERSONAL:** Do you need God’s help to live the way He wants you to according to the scriptures found in this lesson? Why not ask His help now? Philippians 4:13 says, “I can do everything God asks me to with the help of Christ. He gives me strength and power.”

ROMANS - LESSON 11

Before you begin your lesson:

- a. Pray for God's Holy Spirit to help you answer the questions.
- b. Some questions may be too hard; it's ok to write "I don't know."
- c. Think about what God's Word is telling you for today.
- d. With some questions, it might be helpful to write the scripture verses on your paper.

Read Romans chapter 13, verses 1 - 7.

1. Every country has people who make laws and punish anyone who breaks the laws. God put these governments in place. How must we act toward these rulers?

2. What reason does 1 Peter 2:14,15 give for doing this?

3. **CHALLENGE:** What happens to people who don't obey the rulers?

4. What do these verses say about rulers?

Daniel 2:21

Romans 13:4

5. What does 1 Timothy 2:1,2 say is your responsibility for everyone who has authority over you?

6. What does Titus 3:1,2 remind Christians to do?

7. Beside paying what we owe to people what else should we give them?

Read Romans chapter 13, verses 8 - 14.

1. To have a debt means you owe someone something, usually it's money. But what debt does Paul tell you is the only debt to have?

2. What do these verses say about love?

Leviticus 19:18

Matthew 5:43,44

John 13:34,35

Romans 13:10

3. 1 Corinthians 13 is called the “love chapter” of the Bible. Below is 1 Corinthians 13:4-8, as found in *The Bible for Children, The Simplified Living Bible Text*. Underline what love is; circle what love is not.

“Love is very patient and kind. It is never jealous or envious. It never boasts or is proud. It is never haughty or selfish or rude. Love does not demand its own way. It is not angry. It does not hold grudges. It will hardly notice when others do it wrong. It is never glad about things that are wrong. It is happy when truth wins out. If you love someone you will be loyal to him no matter what the cost. You will always believe in him. You will always expect the best of him. You will always stand your ground and defend him. All the gifts and powers from God will someday come to an end. But love goes on forever.”

4. **HARD:** What is the hour these verses tell you is about to come? (*Night* refers to the present time, and *day* refers to Christ’s return.)

Acts 1:9-11

1 Thessalonians 5:10

James 5:8

1 Peter 4:7

5. What are the two things Romans 13:14 tells you to do?

ROMANS - WEEK TWELVE

DISCUSSION LESSON ELEVEN

15 - 20 minutes free time - games; fellowship

15 - 20 minutes snack and group recreation: NEWSPAPER BALL TOSS

Wad up newspaper into fist-size balls, about 12. All players stand behind goal line. Place a container, basket, can, hat, box, etc. about a foot from goal line. (Test the distance by tossing all twelve balls at once into the container to see that the first toss is an easy one.) Each player throws the twelve balls together at the container. The number of balls landing in the container is the player's score. After all players have had a turn, move the container a little further away. Do this about 5 times. The player with the highest score, wins.

15 - 20 minutes discuss LESSON 11

to end of class CRAFT: COASTERS

MATERIALS

lids from margarine, cottage cheese, or yogurt containers
old greeting cards, comic strips, magazines, leaves, etc.
glue
scissors
pencil
spray shellac

Have enough lids for each child to make at least two coasters, more if possible.

Have each child choose the pictures wanted for his coaster.

Trace the lid onto pictures and cut out.

Glue pictures to top of lid and allow to dry.

When dry, spray with three coats of shellac. This makes them waterproof.

ROMANS LESSON 11 ANSWERS

Read Romans chapter 13, verses 1 - 7.

1. Every country has people who make laws and punish anyone who breaks the laws. God put these governments in place. How must we act toward these rulers? Verse 1: “Obey the rulers because God is the one who has put them there. There are no rulers anywhere that God has not put in power.” [You may have some questions regarding obedience to governments that seem to be evil or bad. Hopefully the information given here will answer those questions. Christians should not obey governments that force them to disobey God, or go against what God has ordered. In Acts 4:18-20 we have the example of Peter and John refusing to stop telling about salvation through Jesus Christ. Personal reasons for disobedience is not an option, only following God’s law is the way Christians are to live. Example: the speed limit law is set up for the protection of all on the road. Just because a person is a Christian, does not give him the freedom to break the speed law. God expects His people to submit to the laws set up by the government. “The believer has opposed bad government and supported good government on the theory that good government is the one ordained of God. The believer is for law and order, as over against lawlessness. He is for honesty and justice, as over against corruption and rank injustice” (McGEE).

2. What reason does 1 Peter 2:14,15 give for doing this? “Also obey the king’s officers. They have been sent by the king to punish all that do wrong. They also honor those who do right. God wants your good lives to silence foolish men.”

3. **CHALLENGE:** What happens to people who don’t obey the rulers? Verse 2: “So those who refuse to obey the laws of the land are refusing to obey God. They will be punished.” [“God supports law and order. When we break an established law that does not violate the clear teaching of Scripture, then we are in effect disobeying the Ruler over all” (SWINDOLL).]

4. What do these verses say about rulers?

Daniel 2:21 “World events are under his control. He gets rid of kings and puts others on their thrones. He gives wise men their wisdom and gives scholars their knowledge.” [“The biblical picture is that God by his grace not only sends us good leaders at times, but also bad leaders at other times to punish us. God does not ordain any one form of government to continue forever. The best form of government for a nation is whatever God has brought into being” (STEDMAN).]

Romans 13:4 “The policeman is sent by God to help you. But if you are doing something wrong, you should be afraid. He will have you punished. He is sent by God to do that.”

5. What does 1 Timothy 2:1,2 say is your responsibility for everyone who has authority over you? “I direct you to pray much for others. Beg for God’s mercy on them. Give thanks for all he is going to do for them. Pray for kings and all who have power over us. Then we can live in peace and quietness. We can spend our time in godly living and thinking much about the Lord.”
6. What does Titus 3:1,2 remind Christians to do? “Remind your people to obey the government and its officers. Tell them to always be obedient and ready for any honest work. They must not speak evil of anyone. They must not quarrel and argue. They should be gentle and truly kind to all.”
7. Beside paying what we owe to people what else should we give them? Verse 7: “Pay everyone whatever he should have. Pay what you owe and be happy about it. Obey the people you should obey. Give honor and respect to everybody who should have it.”

Read Romans chapter 13, verses 8 - 14.

1. To have a debt means you owe someone something, usually it’s money. But, what debt does Paul tell you is the only debt to have? Verse 8: “Pay all your debts except the debt of love for others. You should never finish paying that! If you love them you will obey all of God’s laws.” [The debt of love is a debt to Christ for the love He poured out at the cross. This debt we can not repay, so we owe it to Him to love others.]
2. What do these verses say about love? [One who truly loves seeks the best for others. Their focus is not on themselves, but on others.]

Leviticus 19:18 “Do not seek vengeance. Do not bear a grudge. Love your neighbor as yourself. For I am the Lord.”

Matthew 5:43,44 “There is a saying, ‘Love your friends and hate your enemies.’ But I say love your enemies, too! Pray for those who treat you badly!”

John 13:34,35 “And so I am giving a new command to you now. You must love one another just as much as I love you. Your love will prove to the world that you are my disciples.”

Romans 13:10 “Love does no wrong to anyone. That’s why it keeps all of God’s laws. It is the only law you need.”

3. 1 Corinthians 13 is called the “love chapter” of the Bible. Below is 1 Corinthians 13:4-8, as found in *The Bible for Children, The Simplified Living Bible Text*. Underline what love is; circle what love is not. [What love is not is bold face.]

“Love is very patient and kind. It is **never jealous or envious. It never boasts or is proud. It is never haughty or selfish or rude.** Love **does not demand its own way**. It is **not angry. It does not hold grudges.** It will **hardly notice when others do it wrong.** It is **never glad about things that are wrong.** It is happy when truth wins out. If you love someone you will be loyal to him no matter what the cost. You will always believe in him. You will always expect the best of him. You will always stand your ground and defend him. All the gifts and powers from God will someday come to an end. But love goes on forever.”

4. **HARD:** What is the hour these verses tell you is about to come? [*Night* refers to the present time, and day refers to Christ’s return. There is no timetable for this time.]

Acts 1:9-11 “Not long after this, Jesus rose into the sky. He went up into a cloud, leaving them staring after him. They were straining their eyes for another look at him. But suddenly two white-robed men were standing there with them. They said, ‘Men of Galilee, why are you standing here staring at the sky? Jesus has gone to Heaven. And someday he will come back again, just as he went!’”

1 Thessalonians 5:10 “Christ died for us so that we can live with him forever. It won’t matter if we are dead or alive at the time of his return.”

James 5:8 “Yes, be patient. Take courage, for the coming of the Lord is near.”

1 Peter 4:7 “The end of the world is coming soon. Therefore be earnest, thoughtful men of prayer.”

5. What are the two things Romans 13:14 tell you to do? “Ask the Lord Jesus Christ to help you live as you should. Don’t make plans to enjoy evil.” [Christians should not act like those who are not saved.]

ROMANS - LESSON 12

Before you begin your lesson:

- a. Pray for God's Holy Spirit to help you answer the questions.
- b. Some questions may be too hard; it's ok to write "I don't know."
- c. Think about what God's Word is telling you for today.
- d. With some questions, it might be helpful to write the scripture verses on your paper.

Read Romans chapter 14, verses 1 - 8.

In Romans, Paul is writing to believers in Jesus Christ, Christians. In this chapter, Paul talks about the customs connected with eating certain foods and worshipping on certain days. Not everyone agreed on these ideas. And because there was disagreement about ideas and issues that were not written in God's Word, and were not part of the salvation message, there was trouble in the churches. People acted selfishly with fights and arguments. God did not want His early church to be divided. And God does not want division and arguments in His church today. So, when you have a friend whose church has customs that are different than your church, remember what Paul told the early church: "Don't do anything that will make people hate you" (Romans 14:16).

1. When someone becomes a Christian, they begin to learn about God, Jesus, and the way a Christian is supposed to live. So they are called "weak in their faith," but they are growing stronger every day. It takes time to learn the things of God. What do these verses say those who have been Christians for a long time and are stronger in their faith, are to do for those whose faith is weak?

Romans 14:1

2 Corinthians 6:3,4

1 Thessalonians 5:14

2. How are Christians supposed to act towards each other when they have different ideas? Remember, Paul is talking about certain foods, but he could have been talking about any idea or issue. See Romans 14:3 to help with your answer.
3. What does Matthew 7:1 say which is like Romans 14:4?

4. What does Colossians 3:17 say in one verse that took Paul three verses to say in Romans 14:5-8?
5. Romans 14:8 says, "Living or dying we follow the Lord. Either way we are his." This is not a new idea. Shadrach, Meshach, and Abednego said almost the same thing to King Nebuchadnezzar. What did they say in Daniel 3:17,18?

Read Romans chapter 14, verses 9 - 13.

1. What does 2 Corinthians 5:15 say about Jesus?
2. What questions does Paul ask in Romans 14:10?
3. What does God say will someday happen?
4. What do these verses say that is like Romans 14:12?
Matthew 12:36

1 Peter 4:5
5. What does Paul tell us to stop doing?
6. What do these verses say we should do instead of judging others?
Matthew 7:12

Ephesians 2:10

1 Peter 4:8

Read Romans chapter 14, verses 14 - 23.

Remember, Paul uses the type of food someone eats as an example of the freedom believers have in Jesus. You may believe it is okay to do many things, like playing card games. But for your Christian friend, it would be wrong. So in order for your friend not to feel he is doing something wrong, you don't play card games when you are together. Pastor Ray Stedman gives this example of what Paul is saying in verses 14-18.

“We can compare this to crossing a swinging bridge over a mountain stream. Some people can run across such a bridge even though it does not have handrails. They are not concerned about the swaying of the bridge, or the danger of falling into the torrent below. But others are very uncertain on such a bridge. They shake and tremble; they inch along. They may even get down on their hands and knees and crawl across. But they will make it if you just give them time, if you let them set their own speed. After a few crossings they begin to pick up courage, and eventually they are able to run right across.

“It is the same way with these moral questions. Some people cannot see themselves acting in a certain area that they have been brought up to think is wrong. As in the case of the swinging bridge, it would be cruel for someone who had the freedom to cross boldly to take the arm of someone who was timid and force him to run across. He might even lose his balance and fall off the bridge.

“It is wrong to do that. It is not loving to force people to move at your pace. To refuse for someone else's sake to indulge in a freedom—to adjust to his pace—is surely one of the clearest and truest exercises of Christian love.”

1. What is God's kingdom like?
2. **HARD:** Edification means: “Mental or moral improvement” (HOLT). According to verses 18-19 how are Christians supposed to live?
3. **PERSONAL:** Which verse have you chosen to memorize this week? Why not share it with your class? You might try this one:
1 Peter 4:8 “Most important of all, continue to show deep love for each other. Love makes up for many of your faults.”

ROMANS - WEEK THIRTEEN

DISCUSSION LESSON TWELVE

15 - 20 minutes free time - games; fellowship

15 - 20 minutes snack and group recreation: BEDLAM

Divide into four teams of equal size. Each team takes one corner of the room or playing field. The play area can be either square or rectangular. On a signal, each team attempts to move as quickly as possible to the corner diagonally across from their corner, performing an announced style of mobility as they go. The first team to get all its members into its new corner wins that particular round. The first round can be running to the opposite corner, but afterwards there are any number of possibilities: walking backward, wheelbarrow racing, piggy back, rolling, somersaults, hopping on one foot, etc. Be creative, or take turns having a team choose the mode of transportation.

15 - 20 minutes discuss LESSON 12

to end of class CRAFT: WINDSOCK

MATERIALS

construction paper
string
scissors
crepe paper streamers

white glue
hole punch
empty ice cream container

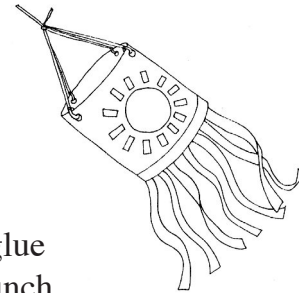

Remove the top and bottom of ice cream container (1/2 gallon size makes a nice “sock”, although quart size container would work as well). Glue various colors of construction paper onto the container, being sure it is completely covered. Or, on white construction paper, draw and color a design before gluing onto the container. Cut long strips of crepe paper streamers, and glue to the inside of one open end. The inside can be decorated with cut shapes from remaining construction paper. (If glue doesn’t hold, try stapling the streamers to the container.) Punch four holes equally spaced around the other open end. Cut string into 6”-8” lengths and thread through holes; double knot. Gather all four strands at the top and knot. Tie a 12” piece of string to the knotted ends and use it to hang windsock.

ROMANS LESSON 12 ANSWERS

Read Romans chapter 14, verses 1 - 8.

In Romans, Paul is writing to believers in Jesus Christ, Christians. In this chapter, Paul talks about the customs connected with eating certain foods and worshipping on certain days. Not everyone agreed on these ideas. And because there was disagreement about ideas and issues that were not written in God's Word, and were not part of the salvation message, there was trouble in the churches. People acted selfishly with fights and arguments. God did not want His early church to be divided. And God does not want division and arguments in His church today. So when you have a friend whose church has customs that are different than your church, remember what Paul told the early church: "Don't do anything that will make people hate you" (Romans 14:16).

1. When someone becomes a Christian, they begin to learn about God, Jesus, and the way a Christian is supposed to live. So they are called "weak in their faith," but they are growing stronger every day. It takes time to learn the things of God. What do these verses say that those who have been Christians for a long time and are stronger in their faith should do for those whose faith is weak?

Romans 14:1 "Give a warm welcome to any brother who wants to join you. Do this even though his faith is weak. Don't worry if his ideas are different from yours."

- 2 Corinthians 6:3,4 "We don't want to do anything that will keep people from finding the Lord. No one can find fault with us and blame it on the Lord. In fact, everything we do is to show we are true servants of God."

- 1 Thessalonians 5:14 "Dear brothers, warn those who are lazy. Comfort those who are afraid. Take tender care of those who are weak. And be patient with everyone."

2. How are Christians supposed to act towards each other when they have different ideas? Remember, Paul is talking about certain foods, but he could have been talking about any idea or issue. See Romans 14:3 to help with your answer. "People who eat this kind of meat shouldn't look down on people who don't. If you don't eat meat, don't find fault with those who do. Because God has accepted them to be his children."

3. What does Matthew 7:1 say which is like Romans 14:4? "Don't judge others. Then you won't be judged." [THE MESSAGE says: "Don't pick on people, jump on their failures, criticize their faults—unless, of course, you want the same treatment."]

4. What does Colossians 3:17 say in one verse that took Paul three verses to say in Romans 14:5-8? “And whatever you do or say, be a model of the Lord Jesus. Come with him to God the Father to give him your thanks.”
5. Romans 14:8 says, “Living or dying we follow the Lord. Either way we are his.” This is not a new idea. Shadrach, Meshach, and Abednego said almost the same thing to King Nebuchadnezzar. What did they say in Daniel 3:17,18? “If we are thrown into the flaming furnace, our God can save us. And he will save us out of your hand, O king. But if he doesn’t, even then we will never serve your gods. And we will never worship the gold statue you have made.”

Read Romans chapter 14, verses 9 - 13.

1. What does 2 Corinthians 5:15 say about Jesus? “He died for all so that all who live should not live for themselves. They should spend their lives pleasing Christ who died and rose again for them.”
2. What questions does Paul ask in Romans 14:10? “You, then, why do you judge your brother? Or why do you look down on your brother? For we will all stand before God’s judgment seat” (NIV).
3. What does God say will someday happen? Verse 11: “It is written: ‘As surely as I live,’ says the Lord, ‘every knee will bow before me; every tongue will confess to God’” (NIV). [This judgment is that of the believer’s life of service. It is not the judgment for eternal destiny.]
4. What do these verses say that is like Romans 14:12?

Matthew 12:36 “And I tell you the truth! You must give account on Judgment Day for every careless word you speak.”

1 Peter 4:5 “But remember, they must face the Judge of the living and the dead. They will be punished for the way they have lived.”

5. What does Paul tell us to stop doing? Verse 13: “So don’t judge each other anymore. Instead, live so that you will never make your brother stumble. Don’t do the things your brother thinks are wrong.”
6. What do these verses say we should do instead of judging others?

Matthew 7:12 “Here is a simple, rule-of-thumb guide for behavior: Ask yourself what you want people to do for you, then grab the initiative and do it for them. Add up God’s Law and Prophets and this is what you get” (THE MESSAGE).

Ephesians 2:10 “It is God himself who has made us what we are. He has given us new lives from Christ Jesus. Long ago he planned that we should spend our lives in helping others.”

1 Peter 4:8 “Most important of all, continue to show deep love for each other. Love makes up for many of your faults.”

Read Romans chapter 14, verses 14 - 23.

Remember, Paul uses the type of food someone eats as an example of the freedom believers have in Jesus. You may believe it is okay to do many things, like playing card games. But for your Christian friend, it would be wrong. So in order for your friend not to feel he is doing something wrong, you don't play card games when you are together. Pastor Ray Stedman gives this example of what Paul is saying in verses 14-18.

“We can compare this to crossing a swinging bridge over a mountain stream. Some people can run across such a bridge even though it does not have handrails. They are not concerned about the swaying of the bridge, or the danger of falling into the torrent below. But others are very uncertain on such a bridge. They shake and tremble; they inch along. They may even get down on their hands and knees and crawl across. But they will make it if you just give them time, if you let them set their own speed. After a few crossings they begin to pick up courage, and eventually they are able to run right across.

“It is the same way with these moral questions. Some people cannot see themselves acting in a certain area that they have been brought up to think is wrong. As in the case of the swinging bridge, it would be cruel for someone who had the freedom to cross boldly to take the arm of someone who was timid and force him to run across. He might even lose his balance and fall off the bridge.

“It is wrong to do that. It is not loving to force people to move at your pace. To refuse for someone else's sake to indulge in a freedom—to adjust to his pace—is surely one of the clearest and truest exercises of Christian love” (p175,176).

1. What is God's kingdom like? Verse 17: “For the kingdom of God is not a matter of eating and drinking, but of righteousness, peace and joy in the Holy Spirit” (NIV).
2. **HARD:** Edification means: “Mental or moral improvement” (HOLT). According to verses 18-19 how are Christians supposed to live? “If you let Christ be Lord in these things, God will be glad, and so will others. This is the way to have peace in the church. So try to build each other up.”
3. **PERSONAL:** Which verse have you chosen to memorize this week? Why not share it with your class. You might try this one:

1 Peter 4:8 “Most important of all, continue to show deep love for each other. Love makes up for many of your faults.”

ROMANS - LESSON 13

Before you begin your lesson:

- a. Pray for God's Holy Spirit to help you answer the questions.
- b. Some questions may be too hard; it's ok to write "I don't know."
- c. Think about what God's Word is telling you for today.
- d. With some questions, it might be helpful to write the scripture verses on your paper.

Read Romans chapter 15, verses 1 - 13.

1. What does Paul tell us to do in these verses?

Romans 15:2

1 Corinthians 10:24

2. **HARD:** Why was everything written?

3. How was everything written, according to these verses?

2 Timothy 3:16-17

2 Peter 1:20-21

Read Romans chapter 15, verses 14 - 22.

1. Who did God tell Paul to tell about the gospel, and why?

2. What has Paul been able to do because Jesus has given him the ability to do it?

3. What does Paul want to do?

4. Do you know what the gospel is? Can you tell someone about it? The following verses will help you.

Luke 2:11

Matthew 1:21

John 1:12

1 Corinthians 15:3,4

6. **PERSONAL:** Is Jesus Christ your Savior? Have you asked Him into your life to forgive your sins and to help you live to please God? Why not ask Him now?

Read Romans chapter 15, verses 23 - 33.

1. What are Paul's travel plans?

2. **HARD:** What was he bringing to Jerusalem and why?

Read Romans chapter 16, verses 1 - 27.

In Romans 16:1-16, Paul sends greetings to many people. Don't run over these names too fast. Paul gives important information about the early church and the roles these people played in building that church. The early church was not one building. This was the name for the early Christians. These verses remind us there were many people working alongside Paul. Their service to God was as important as Paul's, even though there are no letters from them included in the Bible. Sometimes we forget there are many people around the world telling others about Jesus. The next time you go to church, remember all the people around your town, and around the world who are telling others the Good News of Jesus Christ.

1. Who risked their lives for Paul?
2. Who was Paul's first convert in Asia?
3. Who were believers in Christ before Paul?
4. What warning does Paul give the Romans in verse 17-18?
5. Paul told someone to write this letter. Who was this person?

God had a plan for Paul's life, and for all the people who knew him. Some people Paul mentions in his letters. Others he does not mention. But that doesn't make the service they did for the Lord any less important. God has a plan for you, too. Do you know what it might be? Look at what God says has to say through His prophet Jeremiah:

Jeremiah 29:11 "For I know the plans I have for you," says the Lord. "They are plans for good and not for evil. I want to give you a future and a hope."

ROMANS - WEEK FOURTEEN

DISCUSSION LESSON THIRTEEN

15 - 20 minutes free time - games; fellowship

15 - 20 minutes snack and group recreation: CHAIN TAG

Two players are chosen to be "IT." They join hands and with their free hand try to tag the other players. The first player tagged joins hands between the two "IT." The remaining players, when tagged, join the tag line between the original two "IT." Only end players ("IT") may tag. It is permissible for a player to break through or go under the joined hands of the line. When the chain has been broken, it must unite again before tagging resumes. The game ends when the last player is caught or when a time limit has been reached. The last two players tagged become "IT." Set boundary lines to restrict play to a small area.

15 - 20 minutes discuss LESSON 13

to end of class CRAFT: FUN SCIENCE

MATERIALS:

paper plate	scissors
red & blue paint/brushes	string
2-4 oz. lemon juice or vinegar	salt
10-20 dull copper pennies	large clean nail
small glass or jar	hole punch

Cut out the center of the paper plate for your circle [discard outer portion of plate]. Paint one side red; allow to dry. Paint the other blue; allow to dry. Punch two small opposing holes. Thread short lengths of string through each hole. Hold the cardboard by the strings and twirl. The two colors will become one: purple. Experiment with other colors.

Put the pennies in the glass, add a pinch of salt, and cover with juice or vinegar. Let stand 2-3 minutes. Meanwhile, clean the nail. You can use water and scouring powder. When clean, add to the pennies mixture. Wait for 15 minutes, and remove the nail. The nail becomes copper coated. This happens because the copper from the pennies interacts with the acid forming a new compound, called copper citrate, and this compound is what coats the nail. Try rubbing the nail to remove the copper. It is there to stay.

ROMANS LESSON 13 ANSWERS

Read Romans chapter 15, verses 1 - 13.

1. What does Paul tell us to do in these verses?

Romans 15:2 “Let’s try to please other people, not ourselves. Do what is good for them. Build them up in the Lord.”

1 Corinthians 10:24 “Don’t think only of yourself. Try to do what is best for others.”

2. **HARD:** Why was everything written? Verse 4: “These things were written in the Bible long ago. They are there to teach us patience and to make us strong. Then we will look forward to the time when God will conquer sin and death.”

3. How was everything written, according to these verses?

2 Timothy 3:16-17 “The whole Bible was given to us by inspiration from God. It is useful to teach us what is true. It helps us to know what is wrong in our lives. It straightens us out and helps us do what is right. It makes us well prepared and fully equipped to do good to everyone.”

2 Peter 1:20-21 “No prophecy in the Bible was thought up by the prophet himself. The Holy Spirit within these godly men gave them true messages from God.”

Read Romans chapter 15, verses 14 - 22.

1. Who did God tell Paul to tell about the gospel, and why? Verse 16: “Because I am, by God’s grace, a messenger from Jesus Christ to you Gentiles, I bring you the Good News. I offer you up as a sweet-smelling sacrifice to God. You have been made pure and pleasing to him by the Holy Spirit.”
2. What has Paul been able to do because Jesus has given him the ability to do it? Verse 18: “I dare not judge how he has used others. But I know that he has used me to win the Gentiles to God.”
3. What does Paul want to do? Verse 20: “But my ambition has been to go still farther. I want to preach where the name of Christ has never been heard. I don’t want to preach where a church has been started by someone else.”

4. Do you know what the gospel is? Can you tell someone about it? The following verses will help you.

Luke 2:11 “The Savior has been born tonight in Bethlehem! Yes, this is the Messiah, the Lord!”

Matthew 1:21 “She will have a Son, and you shall name him Jesus. This means ‘Savior,’ for he will save his people from their sins.”

John 1:12 “But to all who received him, he gave the right to become God’s children. All they needed to do was to believe in him.”

1 Corinthians 15:3,4 “I passed on to you from the first what has been told to me. Christ died for our sins just as the Bible said he would. He was buried, and three days later he rose from the grave. This happened just as the prophets said it would.”

6. **PERSONAL:** Is Jesus Christ your Savior? Have you asked Him into your life to forgive your sins and to help you live to please God? Why not ask Him now?

Read Romans chapter 15, verses 23 - 33.

1. What are Paul’s travel plans? Verses 24,25: “I am planning to take a trip to Spain. When I do, I will stop off there in Rome. After we have been together for a while, you can send me on my way. But before I come, I must go up to Jerusalem. I have to take a gift to the Jewish Christians there.”
2. **HARD:** What was he bringing to Jerusalem and why? Verses 26,27: “The Christians in Macedonia and Achaia have taken an offering for the poor in Jerusalem. They were very glad to do this. They feel they owe a real debt to the Jerusalem Christians. Why? Because the news about Christ came to these Gentiles from the church in Jerusalem. They received this gift of the Good News from there. So they feel that the least they can do is give them some money.”

Read Romans chapter 16, verses 1 - 27.

In Romans 16:1-16, Paul sends greetings to many people. Don’t run over these names too fast. Paul gives important information about the early church and the roles that these people played in building that church. The early church was not one building. This was the name for the early Christians. These verses remind us there were many people working alongside Paul. Their service to God was as important as Paul’s service, even though there are no letters from them included in the Bible. Sometimes we forget there are many people around the world telling others about Jesus. The next time you go to church, remember all the people around your town and the world telling others the Good News of Jesus Christ.

1. Who risked their lives for Paul? Verses 3,4: “Tell Priscilla and Aquila hello. They have been fellow workers in the work of Christ Jesus. In fact, they risked their lives for me. I am not the only one who is thankful to them. All the Gentile churches are thankful, too.”
2. Who was Paul’s first convert in Asia? Verse 5b: “Greet my good friend Epaenetus. He was the very first person to become a Christian in Asia.”
3. Who were believers in Christ before Paul? Verse 7: “Then there are Andronicus and Junias. They are my relatives who were in prison with me. They are known by the apostles and became Christians before I did. Please give them my greetings.” [They could have been husband and wife, since Junias could be male or female. The mention of being relatives could refer to tribal and not family kin. Although he mentions they were in prison with him, where and when is not mentioned. Use of the word “apostle” could be in the broad, general sense, or for the 12. It is not clear as to who the apostles are, but in any case, they had a favorable reputation among them.]
4. What warning does Paul give the Romans in verse 17-18? “And now there is one more thing to say before I end this letter. Stay away from those who cause divisions and are upsetting people’s faith. They teach things that are not the same as what you have been taught. Such teachers are not working for our Lord Jesus. They only want gain for themselves. They are good speakers, and simple people are fooled by them.”
5. Paul told someone to write this letter. Who was this person? Verse 22: “Tertius is the one who is writing this letter for Paul. He sends his greetings too, as a Christian brother.”

God had a plan for Paul’s life, and for all the people who knew him. Some people Paul mentions in his letters. Others he does not mention. But that doesn’t make the service they did for the Lord any less important. God has a plan for you, too. Do you know what it might be? Look at what God says has to say through His prophet Jeremiah:

Jeremiah 29:11 “‘For I know the plans I have for you,’ says the Lord. ‘They are plans for good and not for evil. I want to give you a future and a hope.’”